

TATA STEEL



Trimapanel®

External wall panel system



Contents

- 4-5 Introduction and benefits
- 6 Platinum® Plus system guarantee
- 7 Colorcoat® products and services
- 8-10 System performance data
- 11 Summary of Building Regulations requirements for the conservation of fuel and power
- 12-13 Wall application model specification
- 14-27 Construction details
- 28-29 Integrated window
- 30-33 Site guidance
- 34 Fasteners, sealants and fillers





Tata Steel

Tata Steel is Europe's second largest steel producer. Our comprehensive range of high quality products and services are supported by steel making sites in the UK and The Netherlands, a European-wide distribution and service centre network and downstream businesses ranging from tubes and building systems to plating.

Our approach to business is unique. We believe our strength is how we build collaborative relationships that create new success for our customers, adding value to their business and helping them to perform in their markets. As a company, we are dedicated to managing our operations responsibly and to continuously improving our performance. We operate in a way that is safe for our people and which respects the environment, with care towards the communities surrounding our operations and beyond.

Sustainability

Steel is an essential material, intrinsic to our way of life and to the products society will demand in a sustainable future. Steel is a material that is used, not consumed. It is recycled and used again, without any loss of quality, time after time. At Tata Steel, we are committed to making the products society needs and to making them in the most responsible way possible.

This means, practically, that we commit to:

- Producing steel products for the future.
- Investing in sustainable steel making.
- Improving our existing processes.
- Facilitating the recycling loop.

Building envelope

Tata Steel has extensive panel and profiling manufacturing capabilities. We are the only company able to offer a comprehensive range of insulated panels, built-up systems, façades, structural roof and floor decking profiles from one single UK source, with the support and backing of a truly global company and complete supply chain.

With such a diverse product portfolio and over 50 years experience, we are uniquely able to offer the specifier an unbiased solution to meet the design criteria for any project.

Trimapanel®

Trimapanel® is an insulated, secret-fix, flat architectural wall-cladding panel that is quick and easy to install for fast build times. Available in a range of sizes, shapes, and colours, and with extensive fabrication options, it offers a design flexibility that enables architects to create unique and modern design solutions.

Trimapanel® FTF System

Standard Trimapanel® requires secondary support steel work. Trimapanel® FTF is an enhanced panel with the ability to span up to 8 m, enabling the product to run horizontally between main frame steelwork or alternatively vertically between base and eaves rails. This not only removes the cost of a secondary steelwork support system but reduces the installation program and removes dust traps, providing a clean and attractive finish to the inside of the building.

This product is not covered in this brochure, however further information can be found by visiting our website:
www.tatasteelconstruction.com.

Technical Services

Our dedicated building envelope technical team are available to support you by providing advice on the best product for your project. They are on hand to help you with:

- Detail design.
- Wind load calculations.
- U-value calculations.
- Load span checks.
- Acoustic SRI predictions.
- Specification writing.
- Advice on meeting Building Regulations, maximising BREEAM credits.
- Assistance with SBEM.
- Condensation risk analysis.
- Assistance in product testing.

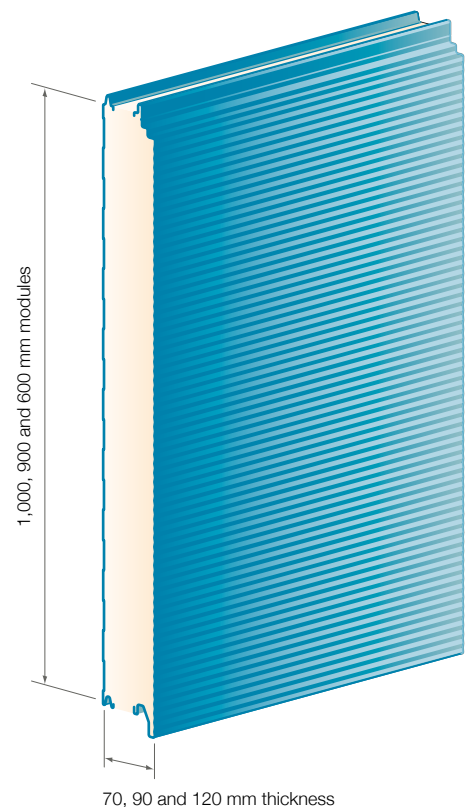



Case study

John Grose

High-profile East Anglian car dealership John Grose required a complete transformation for their showroom and workshop in the coastal location of Lowestoft, Suffolk.

Trimapanel® architectural wall panels in Colorcoat Prisma® were selected to meet the clients requirements of providing a refurbished building envelope solution that both looked modern and would stand the test of time, protected by the 25 year coastal Confidex® Guarantee.

Client: John Grose

Contractor: David Clarke & Associates

Installation contractor: S&G Industrial Roofing Ltd

Cladding system: Trimapanel® System

Colorcoat® product: Colorcoat Prisma® in Silver Metallic

Key benefits: Trimapanel®

- Secret-fix joint design allows primary fixings to be hidden from view and, together with the micro-rib profile, provides flat external aesthetics.
- Flexible design allows vertical and horizontal panel installation.
- Panel lengths up to 12 m and core depths of 70, 90 and 120 mm optimise speed of installation and minimise waste while providing U-values down to 0.17 W/m²K.
- Lower air permeability of the system reduces energy costs, carbon emission rates and facilitates compliance with Building Regulations (Part L2 & TH 6).
- Wide range of flashing, ancillaries, integrated window, integrated louvre, fabricated corner and curved panel options.
- Third party validation of high standards of quality, thermal performance, fire safety, acoustic performance, air-tightness, water penetration and environmental credentials.
- LPCB (Loss Prevention Certification Board) approval to LPS 1181 Part 1 helps reduce insurance premiums and assures reaction to fire performance.
- Fire resistance performance of 15 mins insulation and 4 hours integrity achievable with enhanced fixing methods (horizontally or vertically laid).
- Available with Platinum® Plus system guarantee for 25 years, covering a pre-approved range of reputable, high-end components.
- Colorcoat HPS200 Ultra® or Colorcoat Prisma® pre-finished steel used as standard, offering a wide range of colours and long-term performance for up to 40 years with the Confidex® Guarantee.
- Manufactured in factory conditions operating to quality management standard BS EN ISO 9001:2008 and environmental management standard BS EN ISO 14001:2004.
- Product specification and performance in accordance with BS EN 14509, European Product Standard for CE Marking.
- Full traceability of all component materials and certified 'very good' to BRE's responsible sourcing standard BES 6001.
- Certification to BES 6001 provides independent evidence of our corporate responsibility, and helps increase credits under the Responsible Sourcing of Materials section of BREEAM.



Project: Sir William Ramsey School,
Buckinghamshire

Client: Buckinghamshire County Council

Architect: Jacobs UK Ltd

Main contractor: Trak

Installing contractor: PJB Cladding

Cladding system: Trimapanel® System

Colorcoat® product: Colorcoat Prisma®
in Silver Metallic



Platinum® Plus system guarantee

Platinum® Plus provides a complete building envelope solution guaranteed for 25 years.

Designed in collaboration with our innovative supply chain of leading component manufacturers, our comprehensive portfolios of high quality products are fully integrated to provide the widest range of roofing and cladding systems.

The Platinum® Plus guarantee includes, amongst others, the following components:

- Trimapanel® insulated panel.
- Colorcoat HPS200 Ultra® or Colorcoat Prisma® pre-finished steel.
- Stainless steel fixings.
- Roof lights.
- Sealant.
- Fillers.
- Fall arrest systems.
- Flashings and gutters.

The guarantee is offered directly to building owners, giving a direct link back to Tata Steel as the one point of contact.

For full details of our approved components please contact our technical team on +44 (0) 1244 892199.

To ensure that the building envelope will perform as required by the client, we work with specifiers to tailor a specification that considers the interactions of the components and how they impact the building design and performance. We will then provide a detailed Platinum® Plus specification for use within the project tender package, together with a list of recommended installation contractors.

To guarantee the quality of components used on your building, our team of technical construction experts will visit the site to check for compliance

to specification, reducing the risk of any issues arising in the future.

Once the project is completed the installer will be required to apply for the guarantee using the supplied forms included in the specification document. Tata Steel will then issue the Platinum® Plus guarantee directly to the building owner.

How to raise a specification?

The Platinum® Plus system guarantee needs to be registered with the specifier prior to the tender package being distributed. Please contact our technical team so that we can help you to guarantee the longevity of your building on +44 (0) 1244 892199.



Colorcoat® products and services

Trimapanel® is only supplied with Colorcoat® pre-finished steel for the external and internal skin so that we can provide the very highest quality and service to our customers.

Colorcoat® products and services

The Colorcoat® brand provides the recognised mark of quality and metal envelope expertise exclusively from Tata Steel. For 50 years Tata Steel has developed a range of technically leading Colorcoat® pre-finished steel products which have been comprehensively tested and are manufactured to the highest quality standards. Colorcoat® products manufactured in the UK are certified to BES 6001 Responsible Sourcing standard.

Colorcoat HPS200 Ultra®

The latest generation product for roof and wall cladding, Colorcoat HPS200 Ultra® is the only pre-finished steel product to ensure your building envelope maintains its integrity and aesthetic appeal for up to 40 years with the Confidex® Guarantee with no inspections or maintenance to maintain its validity. For more information visit www.colorcoat-online.com/ultra

Key benefits include:

- Confidex® Guarantee for up to 40 years including cut edges for the weatherside of industrial and commercial buildings.
- 40 standard colours in solid and matt shades.
- Surpasses requirements of Ruv4 and RC5 as per EN 10169:2010 proving outstanding colour retention and corrosion resistance.
- Optimised Galvalloy® metallic coating for exceptional corrosion resistance and cut edge protection.
- Scintilla® embossed as a mark of authenticity from Tata Steel.
- Repertoire® colour matching with a minimum order quantity of 2500 m².
- Exceeds requirements of CPI5 as per EN 10169:2010 demonstrating excellent barrier properties when used internally.

Colorcoat Prisma®

Designed to withstand the rigours of the external environment, versatile, lightweight and strong, Colorcoat Prisma® pre-finished steel is the ideal choice for your building envelope for long lasting colour. With a contemporary new colour range and an optically smooth finish, inspire your imagination. For more information visit www.colorcoat-online.com/prisma

Key benefits include:

- Confidex® Guarantee for up to 30 years including cut edges.
- 27 standard colours in solid, metallic and matt shades.
- All colours surpass requirements of Ruv4 and RC5 as per EN 10169:2010 proving outstanding colour retention and corrosion resistance.
- Optimised Galvalloy® metallic coating for ultimate corrosion resistance and cut edge performance.
- Reverse side branding making traceability easy, so you can rest assured that your building is protected with the highest quality from Tata Steel.
- Repertoire® colour matching service for solid colours with a minimum order quantity of 2500m².

Colorcoat® High Reflect

In addition to the standard liner, we also offer Colorcoat® High Reflect as an option.

Key benefits include:

- ≥ 85% reflectance, reducing the amount of energy required to achieve the same level of lighting.
- Possible energy savings of up to 12% per year.
- Significantly reduces CO₂ emissions by 2-3% per year, helping you to achieve compliance with tightening regulations.

Confidex® Guarantee

Offers the most comprehensive guarantee for pre-finished steel products in Europe and provides peace of mind for up to 40 years. Unlike other guarantees, Confidex® covers cut edges for the entirety of the guarantee period with no inspection or maintenance to maintain its validity.

Includes cover for Colorcoat HPS200 Ultra® pre-finished steel that is under photovoltaic (PV) frame modules, providing the building owner with the confidence that installing a PV array will not have a detrimental effect on the performance of the roof and that the whole roof is guaranteed to perform for the same duration of up to 40 years.



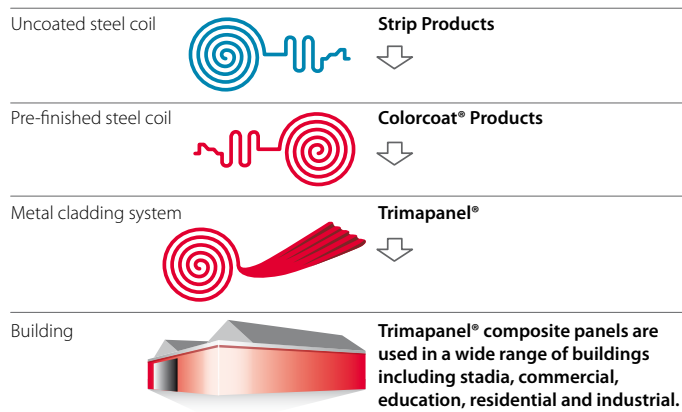



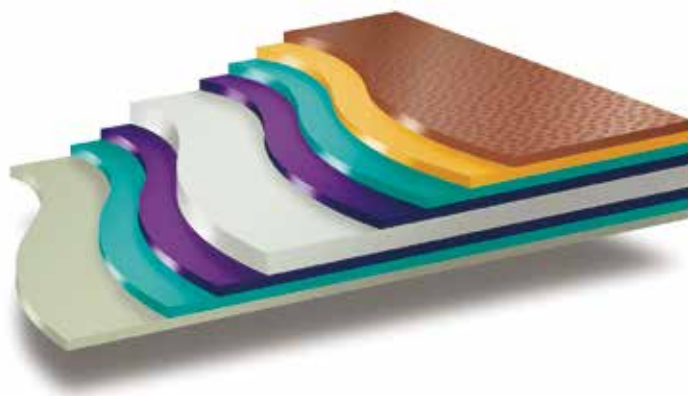

For more information about Colorcoat® products and services call the Colorcoat Connection® helpline on +44 (0) 1244 892 434.



Colorcoat HPS200 Ultra® layers illustration



Key

-  Top coat with unique Scintilla® emboss by Tata Steel
-  Corrosion resistant primer
-  Pre-treatment
-  Galvalloy® metallic coating
-  Base substrate
-  Galvalloy® metallic coating
-  Pre-treatment
-  High performance backing coat

System performance data

Trimapanel® System

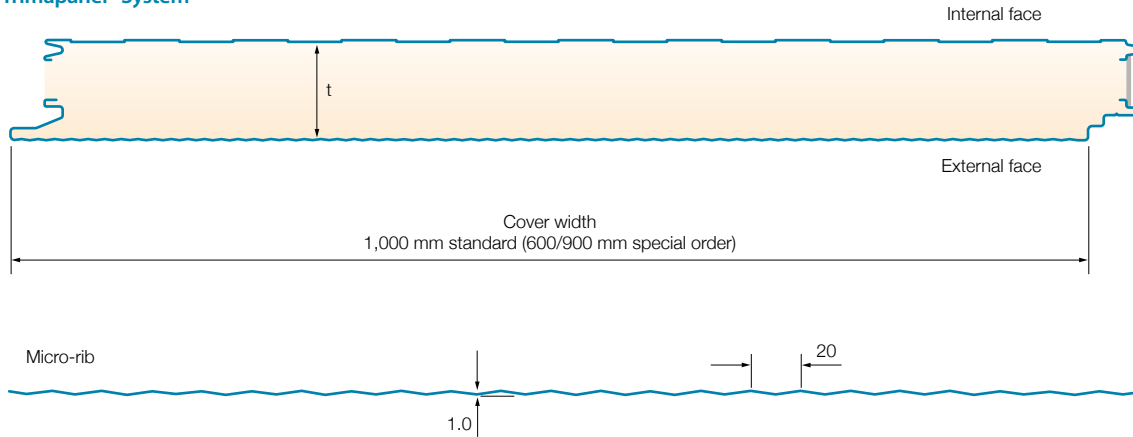

Basic technical data

Thickness, t (mm):	70, 90 and 120
Maximum length (mm):	12,000
Minimum length (mm):	
On-line*	2,400
Off-line	300
Weight (based on thickness mm) (kg/m ²):	
70	11.89
90	12.67
120	13.85

* Panels ordered below the minimum on-line length will require off-line cutting and will be subject to a surcharge.

Panel manufacturing tolerance

Flatness (L = length of measurement between high points)	For L = 200 mm, 0.6 For L = 400 mm, 1.0 For L > 700 mm, 1.5
Cover width (mm):	±2
Thickness (mm):	±2
Squareness (mm):	<6
Length (mm) < 3 m:	±5
Length (mm) > 3 m:	±10

Tolerance is in accordance with BS EN 14509.

General reference

All measurements throughout this brochure are referenced in mm unless stated otherwise. Technical illustrations are not to scale.

Span/load tables

The span tables below have been created in accordance with BS EN 14509. The values are based on a 0.7 mm external face, 0.4 mm internal liner and a 2.0 mm minimum purlin thickness to a maximum permitted wall cladding deflection of Span/150 under imposed load.

Trimapanel® System

Safe wind imposed (positive) loads (kN/m²)

Span condition	Core thickness (mm)	Span (m)								
		2.0	2.5	3.0	3.5	4.0	4.5	5.0	5.5	6.0
Single	70	3.69	2.57	1.84	1.36	1.02	0.77	0.58	0.44	0.34
	90	4.91	3.58	2.62	1.97	1.51	1.18	0.93	0.74	0.59
	120	6.54	5.15	3.87	2.97	2.31	1.83	1.47	1.19	0.98
Double	70	3.82	2.99	2.29	1.70	1.21	0.91	0.71	0.57	0.47
	90	4.91	3.93	3.12	2.38	1.67	1.24	0.95	0.76	0.62
	120	6.54	5.23	4.35	3.20	2.45	1.79	1.36	1.07	0.87
Multi	70	3.82	2.99	2.27	1.75	1.38	1.09	0.87	0.71	0.51
	90	4.91	3.93	3.11	2.40	1.84	1.44	1.14	0.93	0.77
	120	6.54	5.23	4.35	3.20	2.45	1.93	1.57	1.27	1.05

Trimapanel® System (1 fastener per fixing point)

Safe wind suction (negative) loads (kN/m²)

Span condition	Core thickness (mm)	Span (m)								
		2.0	2.5	3.0	3.5	4.0	4.5	5.0	5.5	6.0
Single	70	-2.11	-1.69	-1.40	-1.20	-1.05	-0.93	-0.75	-0.62	-0.52
	90	-2.11	-1.69	-1.40	-1.20	-1.05	-0.93	-0.75	-0.62	-0.52
	120	-2.11	-1.69	-1.40	-1.20	-1.05	-0.94	-0.84	-0.77	-0.70
Double	70	-1.05	-0.84	-0.70	-0.60	-0.53	-0.47	-0.42	-0.38	-0.35
	90	-1.05	-0.84	-0.70	-0.60	-0.53	-0.47	-0.42	-0.38	-0.35
	120	-1.05	-0.84	-0.70	-0.60	-0.53	-0.47	-0.42	-0.38	-0.35
Multi	70	-1.05	-0.84	-0.70	-0.60	-0.53	-0.47	-0.42	-0.38	-0.35
	90	-1.05	-0.84	-0.70	-0.60	-0.53	-0.47	-0.42	-0.38	-0.35
	120	-1.05	-0.84	-0.70	-0.60	-0.53	-0.47	-0.42	-0.38	-0.35

Trimapanel® System (2 fasteners per fixing point)

Safe wind suction (negative) loads (kN/m²)

Span condition	Core thickness (mm)	Span (m)								
		2.0	2.5	3.0	3.5	4.0	4.5	5.0	5.5	6.0
Single	70	-3.67	-2.35	-1.63	-1.20	-0.92	-0.68	-0.49	-0.32	-0.20
	90	-4.21	-3.02	-2.10	-1.54	-1.18	-0.93	-0.75	-0.62	-0.52
	120	-4.21	-3.37	-2.79	-2.05	-1.57	-1.24	-1.01	-0.83	-0.70
Double	70	-2.11	-1.69	-1.40	-1.20	-0.92	-0.73	-0.59	-0.49	-0.41
	90	-2.11	-1.69	-1.40	-1.20	-1.05	-0.93	-0.75	-0.62	-0.52
	120	-2.11	-1.69	-1.40	-1.20	-1.05	-0.94	-0.84	-0.77	-0.70
Multi	70	-2.11	-1.69	-1.40	-1.20	-0.92	-0.73	-0.59	-0.49	-0.41
	90	-2.11	-1.69	-1.40	-1.20	-1.05	-0.93	-0.75	-0.62	-0.52
	120	-2.11	-1.69	-1.40	-1.20	-1.05	-0.94	-0.84	-0.77	-0.70

If safe loading shown above is not satisfactory to your requirements, it is possible to adjust performance by using alternative fastener layouts, purlin specifications and/or deflection limits. For further information please contact the Tata Steel Technical Hotline +44 (0) 1244 892199.

Performance benefits



Thermal performance

The Trimapanel® System complies with the minimum requirements of the Conservation of Fuel and Power sections of the Building Regulations, Approved Document Part L2, England and Wales and Technical Handbook – Scotland. The panel construction offers highly consistent insulation performance, and the site-formed junctions provide a practical and effective method of ensuring good thermal performance.

Thickness (mm)	U-value (W/m²K)*
70	0.31
90	0.24
120	0.17

* Tata Steel figures computer modelled in accordance with EN ISO 10211, as stated in MCRMA Technical Note 14.



Fire safety

The Trimapanel® System carries Grade EXT-B and EXT-A approval by the LPCB. Fire resistance performance of 15 mins insulation and 4 hours integrity is also achievable with enhance fixing and methods, contact the technical department for details. The internal surface of the panel complies with Class 'O' in accordance with the Building Regulations when tested to BS 476 Parts 6 & 7 and also achieves a Class B s2 rating in accordance with EN 13501-1.



Acoustic performance

The acoustic performance of the Trimapanel® System has been predicted using software developed by the Department of Applied Acoustics, University of Salford, under a research contract funded by the Metal Cladding and Roofing Manufacturers Association (MCRMA). The results below are based on a 70 mm core.

Frequency (Hz)	SRI Values (dB)*	Frequency (Hz)	SRI Values (dB)*
100	12.5	800	27.6
125	14.0	1,000	29.3
160	15.7	1,250	31.0
200	17.3	1,600	33.0
250	20.6	2,000	34.7
315	22.4	2,500	36.5
400	24.0	3,150	36.7
500	25.8	4,000	34.6
630	27.6	5,000	32.1

Weighted S.R.I $R_w = 28.9\text{dB}$

* The predicted sound reduction index values should only be used to provide guidance for preliminary design and/or appraisal of cladding systems.



Water penetration

In accordance with product standard BS EN 14509, the water-tightness of a system should be tested to EN 12865. The standard advises that the system should achieve water-tightness to a pressure of 600 Pa for normal conditions. The Trimapanel® System's joint is water-tight up to a pressure of 1,050 Pa, which far surpasses this requirement.



Air-tightness

The cladding panel and its junction details must be air-tight so that the air permeability of the building does not exceed 10 m³/h/m² at an applied pressure of 50 Pa, in accordance with the Building Regulations for England and Wales, Part L2 and in Scotland the Technical Handbook, Section 6 Energy. In laboratory tests in accordance with EN BS 12114, the sealed panel show evidence of air leakage as low as 0.48 m³/h/m².

A practical expectation for a finished building, with effective sealing at all junctions would be 5-10 m³/h/m². However enhanced detailing practises on large shed buildings can realise air leakage performance figures of less than 3 m³/h/m².



Environmental credentials

The Trimapanel® System is a sustainable solution with responsible sourcing and traceability of all component materials. All steel elements are produced within the UK through Tata Steel's steel production, strip processing, galvanising, coating and profiling facilities. In addition the system's carbon footprint is further minimised by the manufacturing process being situated adjacent to the Colorcoat® production lines.

The PIR insulation within the system has zero ozone depletion potential (ODP) and a very low global warming potential (GWP) of less than 5. Both these factors support the achievement of a high BREEAM rating. All steel elements are 100% recyclable, without any loss of quality. The insulation can be separated using existing scrap shredding technology, after which the materials can be recovered or recycled.



Summary of Building Regulations requirements for the conservation of fuel and power



Introduction to changes

The latest amendment to the England AD-L2 and Wales Part L Regulations for the conservation of fuel and power (2013) came into effect on 6 April and 31 July 2014 respectively. This is the third amendment following the introduction of these mandatory regulations in 2002. The revision to Section 6 Scotland is scheduled for 2015.

AD-L2 follows the principle of the 2010 Regulations but with significant changes in the definition of the types of buildings that make up the aggregate mix. As before, the whole building is assessed using the SBEM 'whole building methodology' that expresses the energy performance. Since it is the building services that emit CO₂ and not the building elements, the total energy building performance takes account of the CO₂ emission resulting from the provision of heating, hot water, ventilation, cooling and lighting. It is therefore based on the building's use in occupation.

In Part L 2010, two notional buildings were defined for top-lit (warehouses) and side-lit (all other) buildings. In Part L 2013 notional buildings reflect the different energy profiles and building services plant likely to be found in the buildings and are defined for:

- Top-lit (warehouses – further defined by size).
- Side-lit (heated only).
- Side-lit (heated and cooled).

For 2013, the aggregate approach to CO₂ reductions introduced for the 2010 revision have been retained. This means that the CO₂ emissions across the predicted building mix will be 9% lower than the same building mix constructed to 2010 standards.

Table 1

Fabric U-values and backstop levels

AD-L2A England & Wales	2013 Notional building values			2013 Backstop values
	Side-lit/unlit (spec. is heating only)	Side-lit/unlit (spec. includes cooling)	Top-lit	
Roofs	0.18 W/m ² K	0.18 W/m ² K	0.18 W/m ² K	0.25 W/m ² K
Walls	0.26 W/m ² K	0.26 W/m ² K	0.26 W/m ² K	0.35 W/m ² K
Floors	0.22 W/m ² K	0.22 W/m ² K	0.22 W/m ² K	0.25 W/m ² K
Glazing	1.6 W/m ² K	1.6 W/m ² K	N/A	2.2 W/m ² K
Roof light	N/A	N/A	0.18 W/m ² K	2.2 W/m ² K
Roof light (max. area)	N/A	N/A	12% area	N/A
Renewable Energy (Wales only)	5.3%	5.3%	5.3%	5.3%
TPEC (Wales only)				
Section 6 Scotland ⁽¹⁾	Requirements			Max area weighted values ⁽³⁾
Roofs (Scotland)	Pitched - 0.16 W/m ² K - Flat ⁽²⁾ - 0.25 W/m ² K ⁽²⁾			0.20 W/m ² K
Walls (Scotland)	0.30 W/m ² K			0.27 W/m ² K

⁽¹⁾ Values for Scotland are the 2010 levels, due for revision in 2015

⁽²⁾ 'Flat' is defined as 'flat roofs with integral insulation' and includes Insulated Panels

⁽³⁾ Maximum area weighted values for all elements of the same type (see clause 6.2.1)

The total building stock emissions are based on a set of standard building types and occupancy profiles which are defined in the national calculation methodology (NCM).

The actual improvement of a building constructed to 2013 requirements may be more or less than 9%.

There is no correlation for individual buildings. The 9% improvement is an aggregated average across the stock which would be achieved if all buildings were constructed to the notional building specification.

The notional building specification is used to calculate the CO₂ emission target for a building

The designer does not have to use the notional building specification for the actual building but must ensure that the actual building emission rate is ≤ the target emission rate.

For Wales the improvement factor is 20% reduction. The specification for the notional building to achieve this is the same as for England but includes a 5.3% Gross Internal Area (GIA) of PV. Welsh regulations have also introduced a Target Primary Energy.

In order to achieve the 9% target improvement in energy/carbon emissions for 2013, the set values in the notional building have been further improved compared to 2010, including:-

- Lower air permeability rate.
- Improvements to lighting and controls.
- Improved efficiency of services and controls.
- Limitations on the effect of solar gain.

However fabric U-values have been retained at 2010 levels.

Envelope U-values

The U-values used in the 2013 notional (non-domestic) buildings together with the backstop values are the same as the 2010 levels with the exception of window U-values - see Table 1.

There is no differentiation between heated only and heated and cooled buildings in the notional building.

Air Permeability

In AD-L2: 2013 for non-domestic buildings air permeability is the only part of the fabric performance that has been improved beyond the 2010 levels. The major change is that air permeability levels are defined according to 'Gross Internal Area' (GIA) becoming lower as the GIA increases. Following the research shown below and representation from EPIC and MCRMA the levels for smaller top-lit buildings (below 250 m²) have been relaxed to 7 m³/m²/h.

Table 2 illustrates the changes which are shown in m³/(h.m²) at 50 Pa according to GIA. There is a backstop level of 10 m³/(h.m²) at 50 Pa. The 10 m³/(h.m²) limit is a mandatory requirement for all new buildings except those below 500 m² for which 15 m³/(h.m²) can be adopted without testing.

In Scotland, air permeability is expressed as a 'recommended limit' of 10 m³/(h.m²) - the same value as that used in SBEM for Scotland. Testing became mandatory for warrants made after 1 May 2011.

Table 2

Air Permeability levels by Gross Internal Area (GIA)

2013 Notional Building values	Side-lit/unlit (heating only)	Side-lit/unlit (inc. cooling)	Top-lit
	GIA ≤ 250m ²	5 m ³ /(h.m ²)	5 m ³ /(h.m ²)
250m ² < GIA ≤ 3500 m ²	3 m ³ /(h.m ²)	3 m ³ /(h.m ²)	7 m ³ /(h.m ²)
3500 m ² < GIA ≤ 10000 m ²	3 m ³ /(h.m ²)	3 m ³ /(h.m ²)	5 m ³ /(h.m ²)
10000 m ² < GIA	3 m ³ /(h.m ²)	3 m ³ /(h.m ²)	3 m ³ /(h.m ²)

For additional support please contact our Technical Department on 01244 892130.

Wall applications



Model specification

H43 Insulated panel cladding/covering

120 Insulated steel-faced wall panel:

Tata Steel, LPCB approved Trimapanel® System.

Cladding systems in England and Wales to be designed and installed to meet the Building Regulations 2000, Approved Document L2 2013.

Cladding systems in Scotland to be designed and installed to meet the Building Standards (Scotland) Regulations Technical Handbook: Section 6 Energy.

- **Support structure:** Cladding rails
- **Bearing width (minimum):** 140 mm (panel joint positions), 50 mm (intermediates)
- **Manufacturer:** Tata Steel, Shotton, Deeside, Flintshire, CH5 2NH
T: +44 (0) 1244 892199
F: +44 (0) 1244 892121
- **Product reference:** Trimapanel® System
- **Fire:** LPS 1181 Grade EXT-B Certificate No. 460a/28. Internal lining Class O as tested to with BS 476 Parts 6 and 7. Class B s2 in accordance with EN 13501-1.

- **British Board of Agreement (BBA):** Colorcoat® to BBA Certificate No. 91/2717
- **External facing material:** Colorcoat HPS200 Ultra® or Colorcoat Prisma® pre-finished steel using Galvalloy® metallic coating, 0.7 mm nominal thickness, based on a zinc (95%): aluminium (5%) eutectic alloy that conforms to EN 10346:2015.
- **External profile:** Micro-ribbed (MR) with tongue and groove edges.
- **Colour:** See Colorcoat HPS200 Ultra® or Colorcoat Prisma® range of colours.
- **Internal facing material:** Colorcoat® High Reflect, Colorcoat® PE 15 pre-finished steel using hot-dip galvanised steel EN10346:2015 substrate, nominal thickness 0.4 mm.
- **Internal profile:** Planked, with tongue and groove edges.
- **Core insulation:** PIR closed cell foam (CFC and HCFC free, zero ODP and GWP <5) to specification used in LPCB approval.
- **Cover width:** 1,000 mm (600 and 900 mm non-standard widths).
- **Panel thickness:** 70, 90 or 120 mm.

- **Primary fasteners:** Austenitic stainless steel self-drilling fasteners with thread-free zone and 15 mm sealing washers from EJOT UK Limited
T: +44 (0) 1977 687040
SFS intec
T: +44 (0) 113 208 5500
- **Fastener location:** Fix through male-joint edge at support position.
- **Number and location of fasteners:** One fastener per panel per support to be fixed through the male-joint edge. The fastener will be concealed by the tongue of the following panel. For high load conditions two fasteners may need to be specified.
- **U-value:** 0.31 W/m²K for 70mm panel; 0.24 W/m²K for 90mm panel ; 0.17 W/m²K for 120mm panel.

General requirements

170 Design

Wall cladding to be designed to comply with design and installation guidance in Tata Steel literature.

172 Thermal bridging

To reduce thermal bridging follow the construction details found in Tata Steel literature.



480 Flashing and trim details

- **System type:** Use Tata Steel robust details to reduce thermal bridging.
- **Material and finish:** To match outer sheet, 0.7 mm minimum gauge.
- **Manufacturer:** Tata Steel
T: +44 (0) 1244 892199
- **Lap joint treatment:** End joints to be lapped by 150 mm and sealed, unless specified otherwise. Where possible arrange with laps away from the prevailing wind.

Where butt joints are required. Butt joint and seal flashings/ trims on 150 mm wide butt straps made from sheet of the same material and finish.

- **Method of fixing:** Fix to cladding with sealed rivets or austenitic stainless steel self drilling fasteners at 450 mm minimum centres from EJOT UK Limited
T: +44 (0) 1977 687040 or,
SFS intec
T: +44 (0) 113 2085500
- **Design:** Maximum un-stiffened leg on flashing to be 250 mm. Visible free edges to be finished with a stiffened edge or welt.

550 Sealing joints and laps

- **Panel end joint:** Trimapanel® System is jointed at the ends using an internal perimeter gasket and an external metal top-hat section. The top hat section is sealed to the face of the panel with 4 mm diameter high performance butyl strip mastic with a minimum 25 year guarantee (ie, white or pink strip).
- **Side lap joint sealing:** Joint designed with compression fit to central joint area.

554 Water vapour and air sealing

- The metal lining layer must be reasonably air-tight so that the air permeability does not exceed 10 m³/h/m² at an applied pressure of 50 Pa in accordance with the Building Regulations, Approved Document L2 2010. A reasonable practical expectation for a finished system would be 5 to 10 m³/h/m².
- Ensure internal flashings are fully sealed to ensure continuity and effectiveness of seal, especially at corners of sheets such as at roof/wall junctions and at all penetrations of pipes, ducts, etc.



Platinum® Plus system guarantee specification

A Platinum® Plus system guarantee specification needs to be registered prior to tender package being distributed.

Obtaining a 25 year Platinum® Plus guarantee could not be simpler; simply request the guarantee from Tata Steel. Tata Steel acts as the one point of contact from beginning to end. We will provide you with a detailed NBS specification, warranties for all specified elements and full support for the duration of the guarantee period.

Technical Department

For further information or to register your Platinum® Plus system guarantee specification please telephone the Technical Department:
T: +44 (0) 1244 892199.

Construction details

Horizontal details

The details within this section are recommendations and have been designed to give practical solutions to minimise thermal bridging and air loss at junctions. For each junction detail, Ψ values (Psi) and f values have been calculated in accordance with BS EN ISO 10211 and recommendations within MCRMA technical paper 18.

NB. All support steelwork by others.

Panel to panel joint (vertical section)

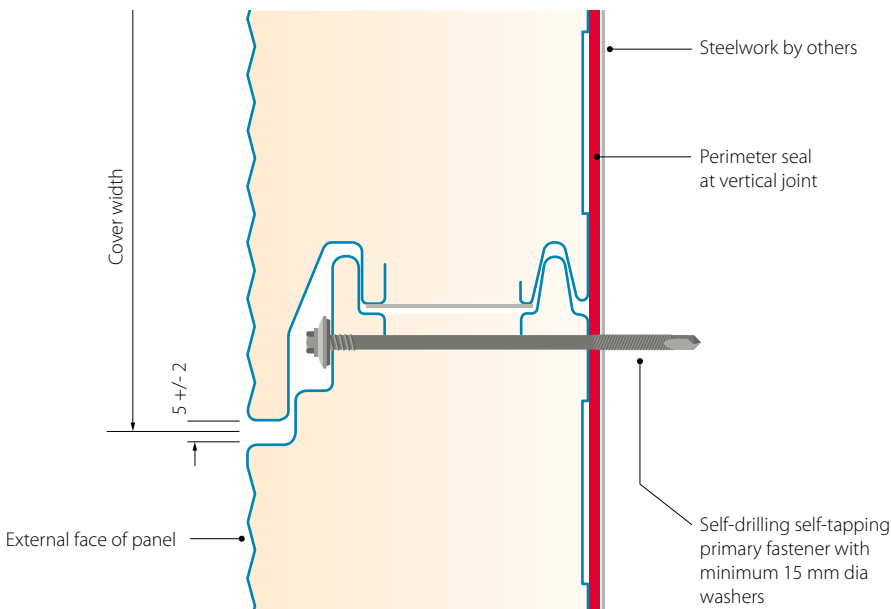

Panel to panel joint (vertical section)

Owing to the unique secret-fix joint design, no panel fixings are visible. The joint compression and the perimeter seal work together to achieve maximum weatherability.

Slab base drip

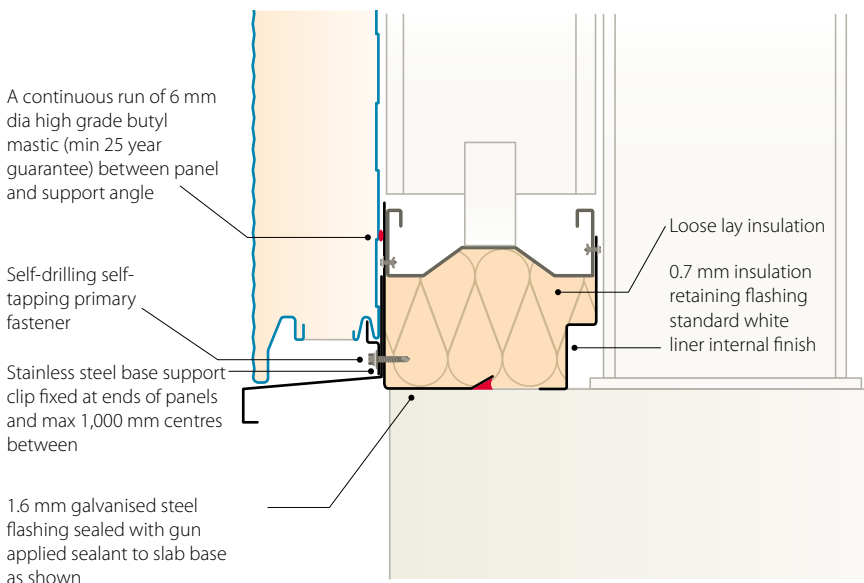

Slab base drip

Loose lay mineral fibre quilt insulation is used below the bottom cladding rail to reduce cold bridging at the slab base.

Psi value (W/mK)	f factor
0.275	0.69

Stated calculation results are dependant on components being as shown. Computer modelled in accordance with EN ISO 10211.

Vertical joint

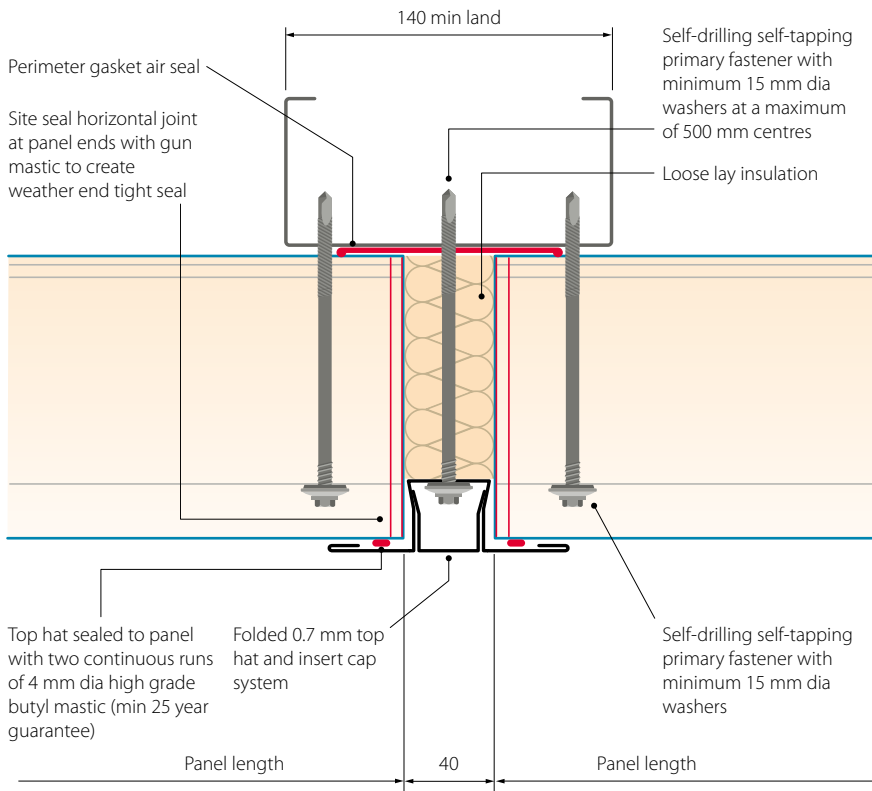

Vertical joint
The top hat and insert-cap system ensures weatherability and acts as an aesthetically pleasing architectural feature.

Dado wall drip

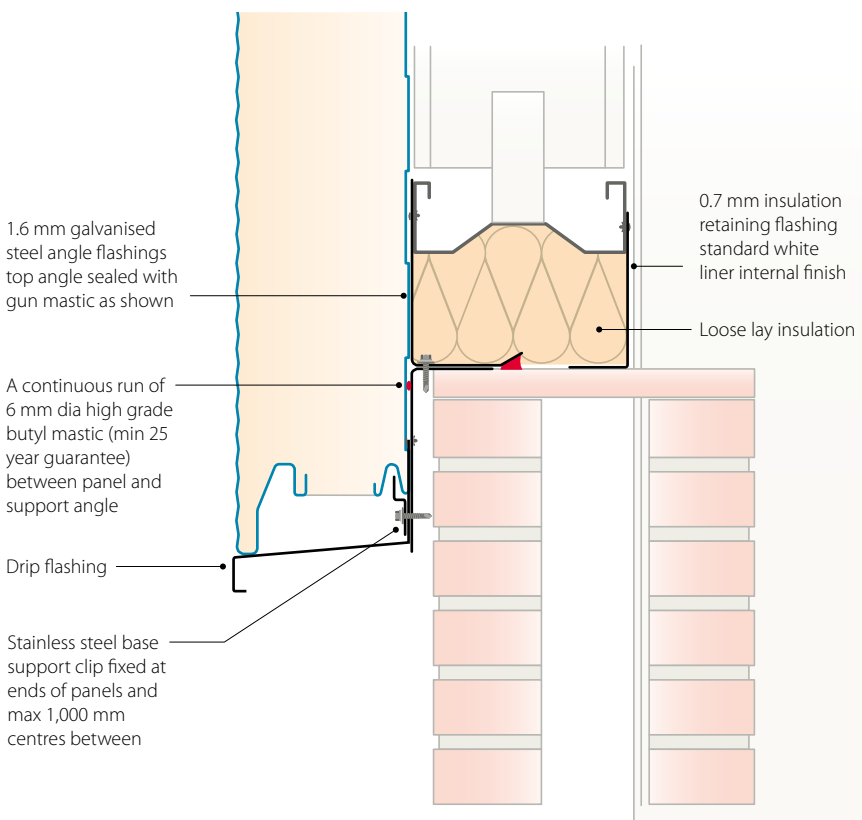

Dado wall drip
The back to back steel angles should be fixed together prior to positioning against bottom rail. This detail reduces cold bridging at this junction. Care must be taken not to over extend from wall capping both horizontally or vertically.

Psi value (W/mK)	f factor
0.48	0.702

Stated calculation results are dependant on components being as shown. Computer modelled in accordance with EN ISO 10211.

Horizontal construction details continued

External corner

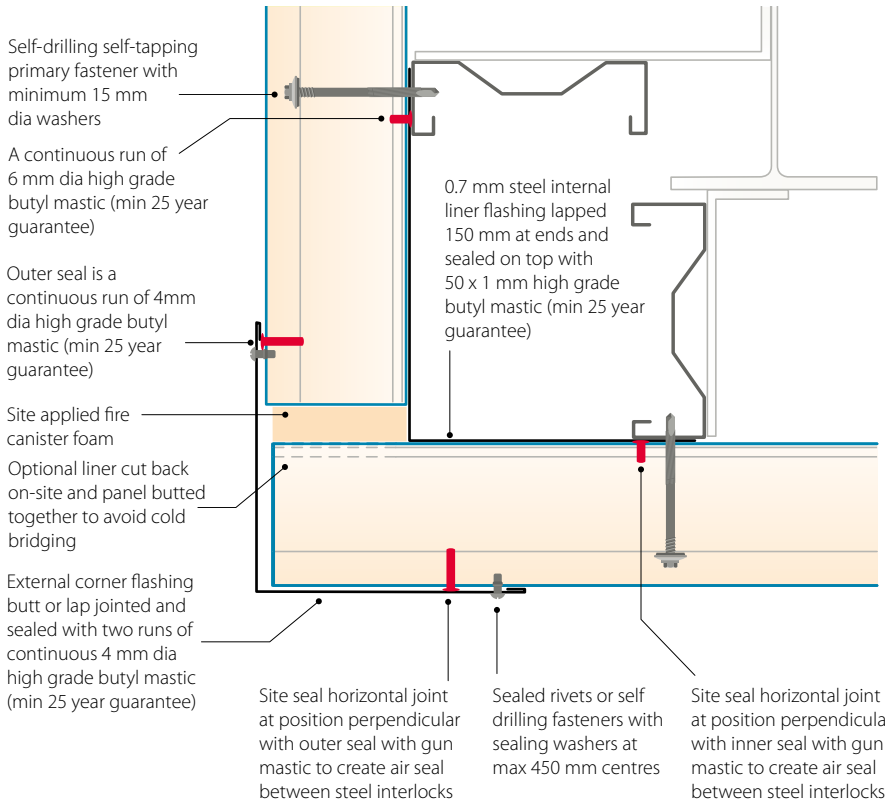

External corner

Thermal performance can be enhanced by on-site removal of the panel liner within the corner junction, thereby reducing the risk of cold bridging. The liner can be easily removed by running a circular saw through the steel approximately 100 mm from the panel edge and peeling away the cut strip.

Psi value (W/mK)	f factor
With liner cut back	
0.011	0.977
Without liner cut back	
0.17	0.93

Stated calculation results are dependant on components being as shown. Computer modelled in accordance with EN ISO 10211.

Fabricated external corner

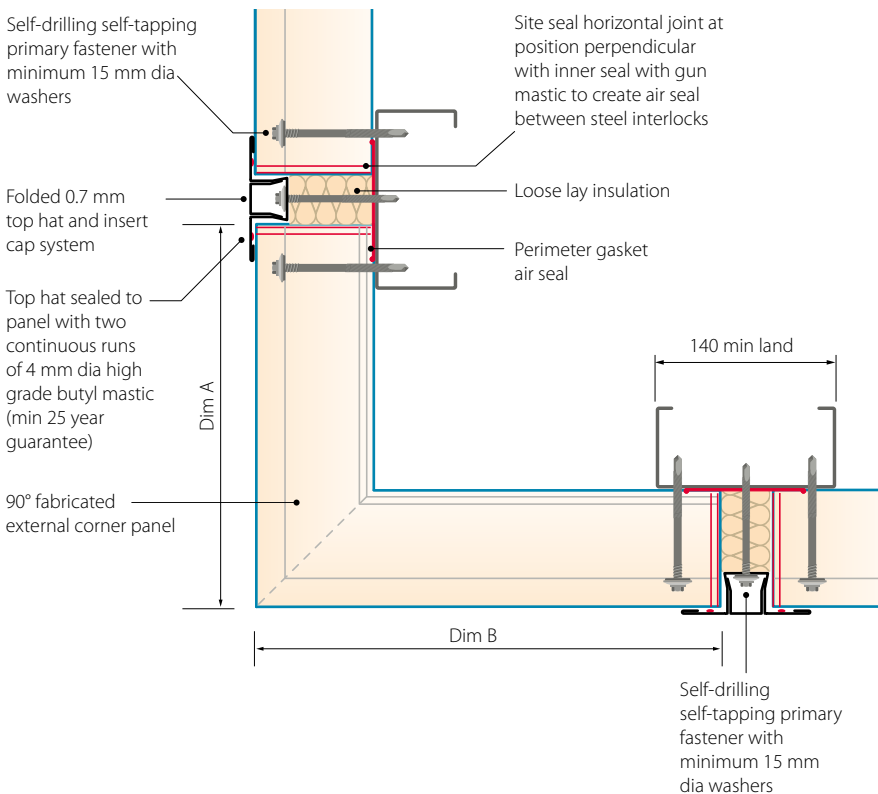

Fabricated external corner

Factory fabrication provides an aesthetically pleasing solution to the corner detail and also provides a consistent thermal and air-tightness performance.

Maximum standard unit size			
	70 mm	90 mm	120 mm
Dim A +			
Dim B	1500	1500	1500

Larger sizes can be accommodated, however these will be subject to an extra cost, please contact the sales or technical departments for further information.

Minimum standard unit size (based on a 90° corner)			
	70 mm	90 mm	120 mm
Dim A or B not to be less than	170	190	220
and/or (Dim A + Dim B) must be ≥ 800 mm			

Internal angle

Max	No maximum
Min	45 degrees

Internal corner

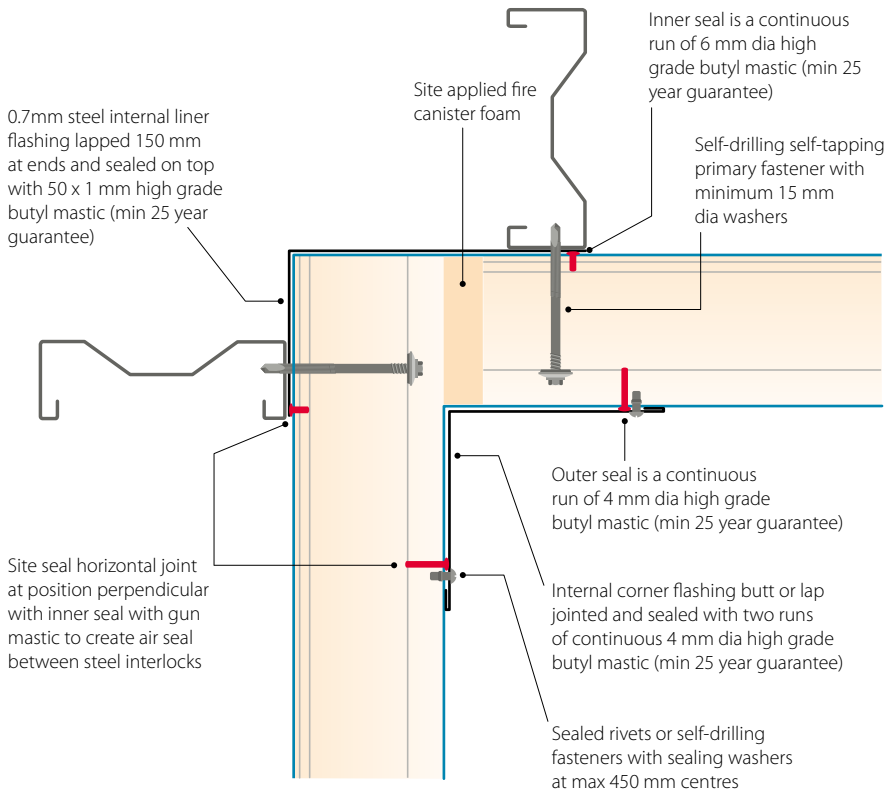

Internal corner

Thermal performance can be enhanced by on-site removal of the panel outer skin within the corner junction, thereby reducing the risk of cold bridging. The outer skin can be easily removed by running a circular saw through the steel approximately 100 mm from the panel edge and peeling away the cut strip.

Psi value (W/mK)	f factor
With liner cut back	
0.011	0.977
Without liner cut back	
0.17	0.93

Stated calculation results are dependant on components being as shown. Computer modelled in accordance with EN ISO 10211.

Fabricated internal corner

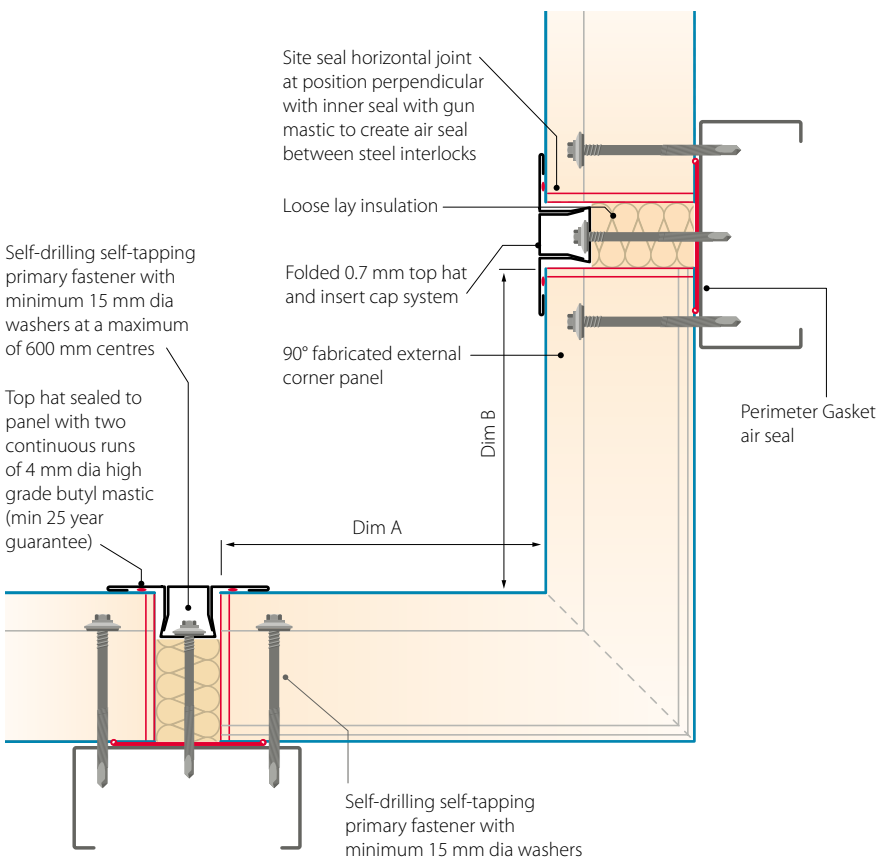

Fabricated internal corner

Factory fabrication provides an aesthetically pleasing solution to the corner detail and also provides a consistent thermal and air-tightness performance.

Maximum standard unit size			
	70 mm	90 mm	120 mm
Dim A + Dim B	1500	1500	1500

Larger sizes can be accommodated, however these will be subject to an extra cost, please contact the sales or technical departments for further information.

Minimum standard unit size (based on a 90° corner)

Dim A or Dim B should not be less than 100 mm.

and/or (Dim A + Dim B) + (2 x Core thickness) must be ≥ 800 mm.

Internal angle

Max	No maximum
Min	45 degrees

Horizontal construction details

continued

Eaves

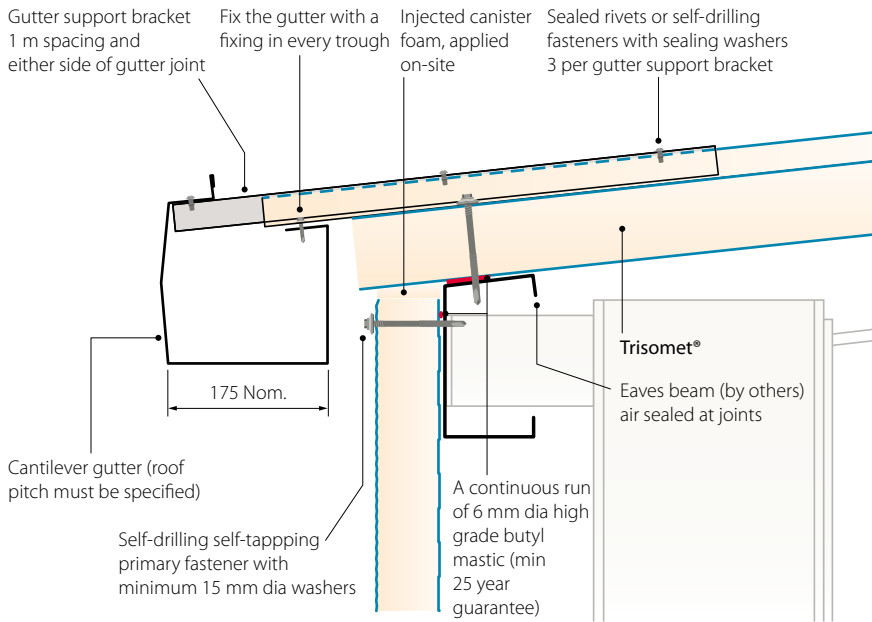

Eaves

If the top panel requires cutting, fix back to the eaves beam support at a maximum of 1,000 mm centres, no less than 30 mm from the panel cut edge. For the panel cut we recommend using a circular saw that produces a cold cut with a fine-tooth metal cutting blade (ie, not a grinding blade, as this hot cut will damage the coating).

Psi value (W/mK)	f factor
0.222	0.903

Stated calculation results are dependant on components being as shown. Computer modelled in accordance with EN ISO 10211.

Verge

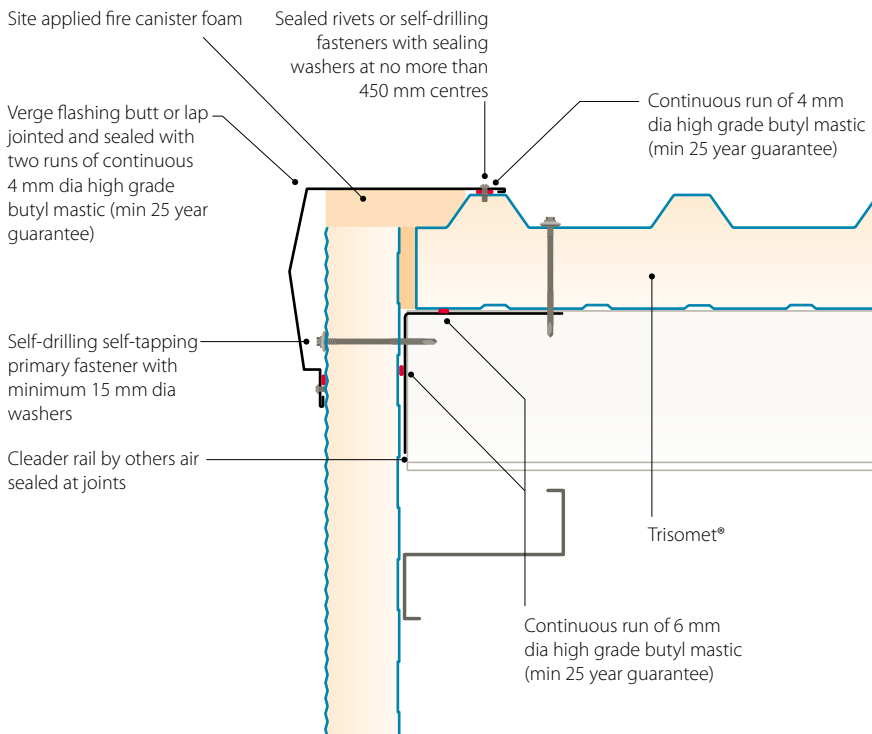

Verge

For ease of installation finish the roof panel at outer edge of the support cleat to allow the wall panel to be laid without obstruction and allowing insulation packing of the junction to be carried out from above.

Psi value (W/mK)	f factor
0.062	0.918

Stated calculation results are dependant on components being as shown. Computer modelled in accordance with EN ISO 10211.

Horizontal construction details

continued

Penetration, standard

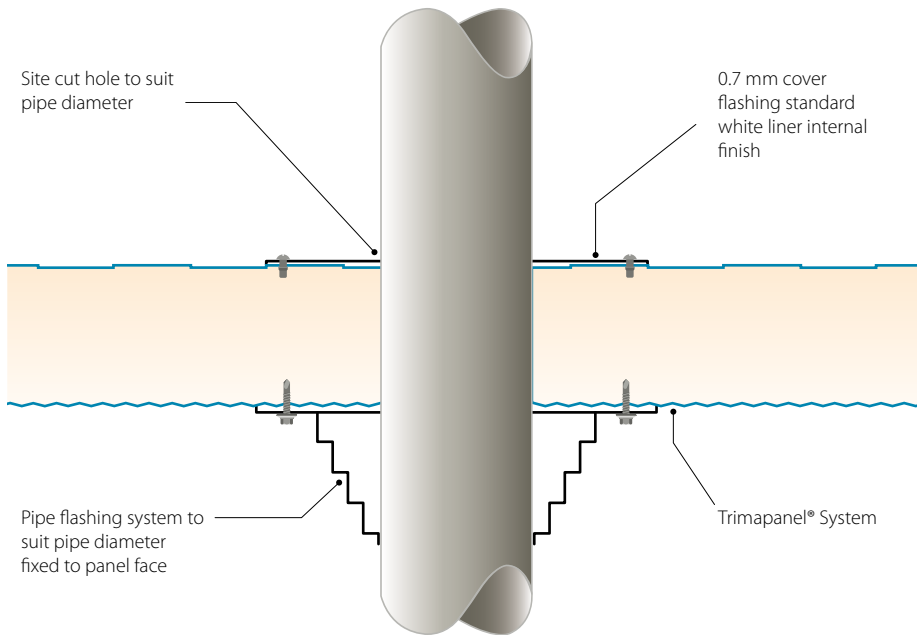

Penetration, standard

The pipe flashings are available in various specifications to facilitate different opening sizes and temperature ranges. Further details on these specifications and for order placement please contact our Platinum® Plus system guarantee approved suppliers, who are:
 SFS intec
 T: +44 (0) 113 2085 500 or
 EJOT UK Limited
 T: +44 (0) 1977 687040

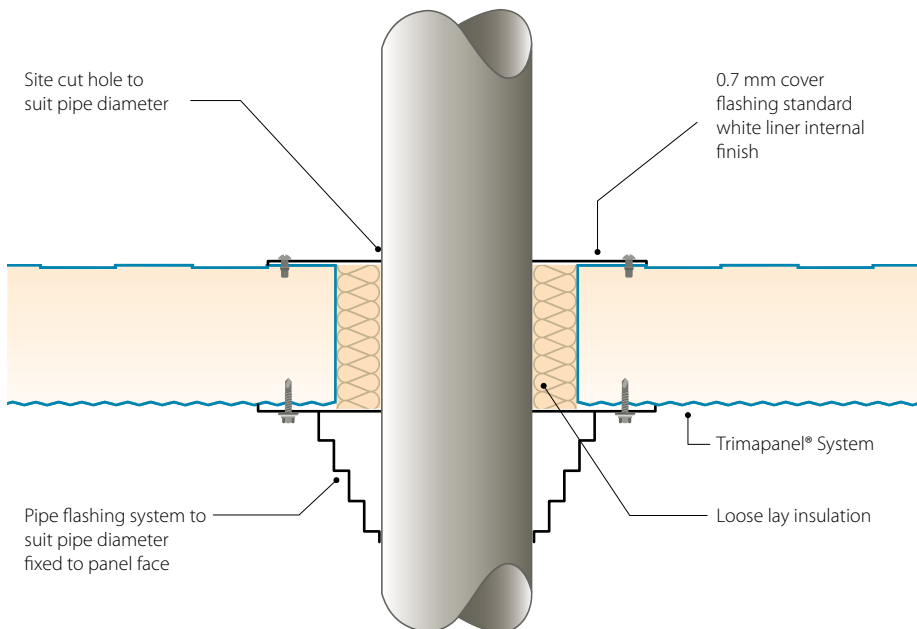

Vertical to horizontal break

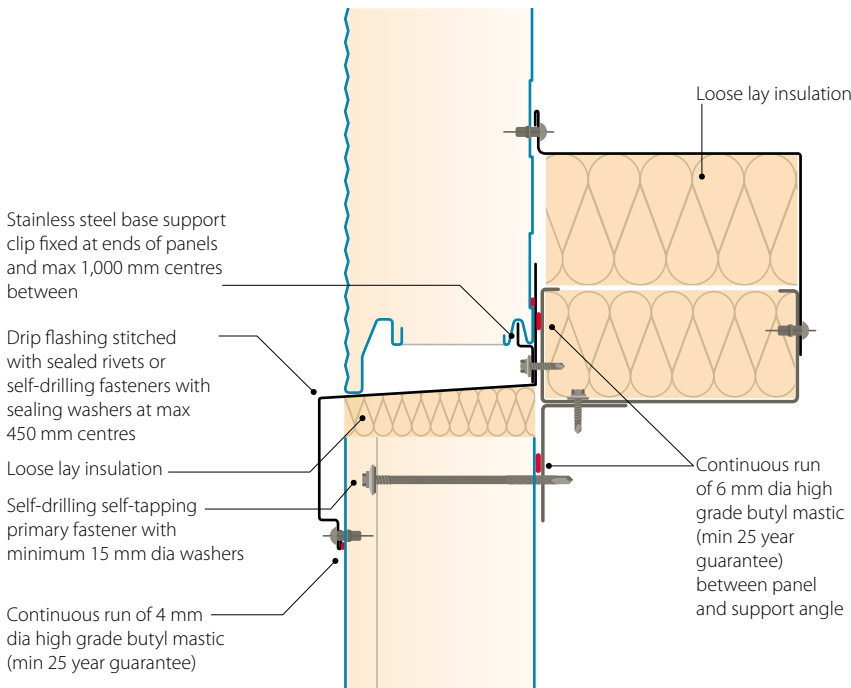

Vertical to horizontal break
Horizontal and vertical panels can be installed adjacent to each other to create interesting architectural features, while the drip flashing detail still maintains thermal performance and an efficient weather seal.

Psi value (W/mK)	f factor
0.103	0.579

Stated calculation results are dependant on components being as shown. Computer modelled in accordance with EN ISO 10211.

Brick wall abutment

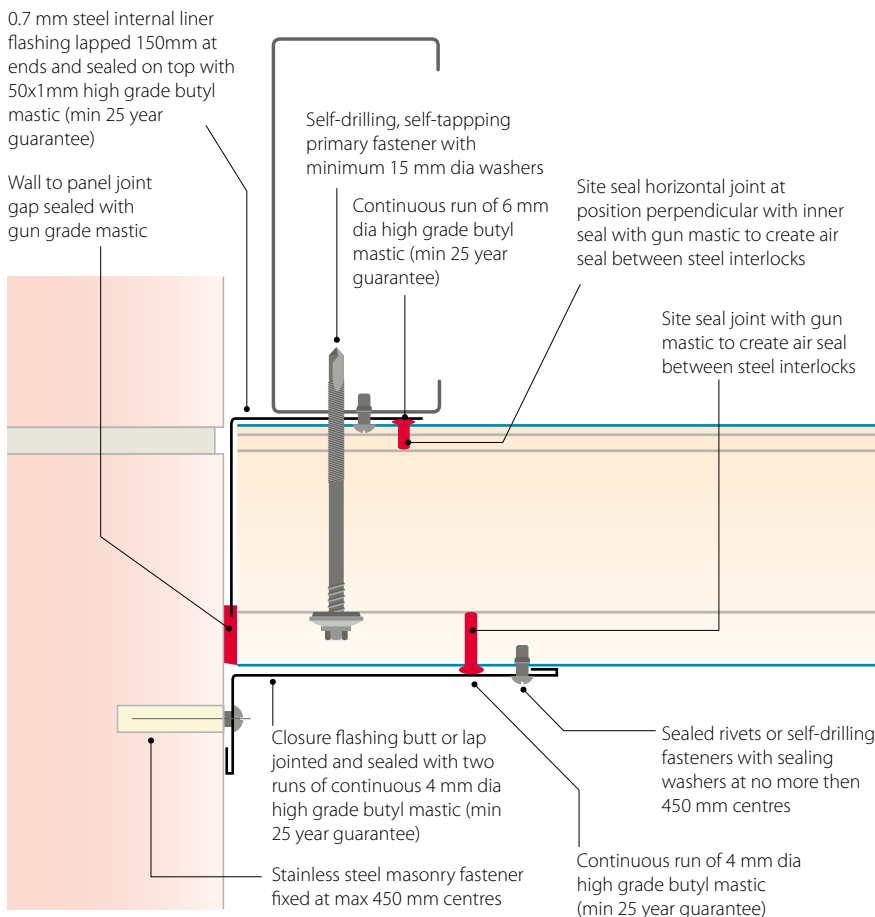

Brick wall abutment
Masonry fasteners should be stainless steel to maintain the durability of the system.

Psi value (W/mK)	f factor
0.26	0.84

Stated calculation results are dependant on components being as shown. Computer modelled in accordance with EN ISO 10211.



Project: Four Ashes Energy Recovery Facility

Client: Staffordshire County Council

Main Contractor: Clugston

Installing Contractor: Northern Cladding

Cladding system: Trimapanel® system

Colorcoat® product: Colorcoat Prisma® and Colorcoat HPS200 Ultra® exterior and Colorcoat HPS200 Ultra® interior due to harsh environment

Construction details

Vertical details

Panel to panel joint (horizontal section)

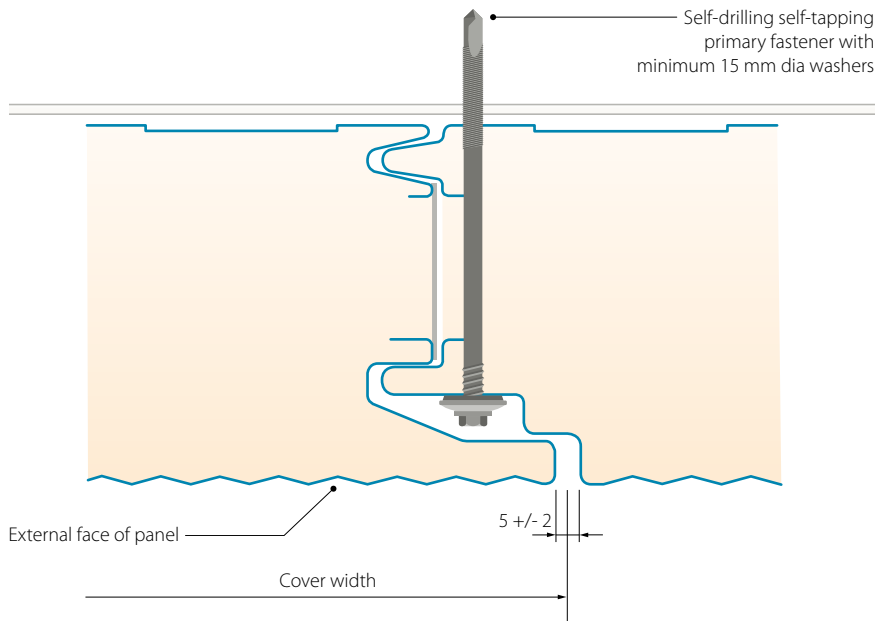

Panel to panel joint (horizontal section)

Owing to the unique secret-fix joint design, no panel fixings are visible. The factory applied seal and the perimeter seal work together to achieve a weather-tight system.

Stack Joint

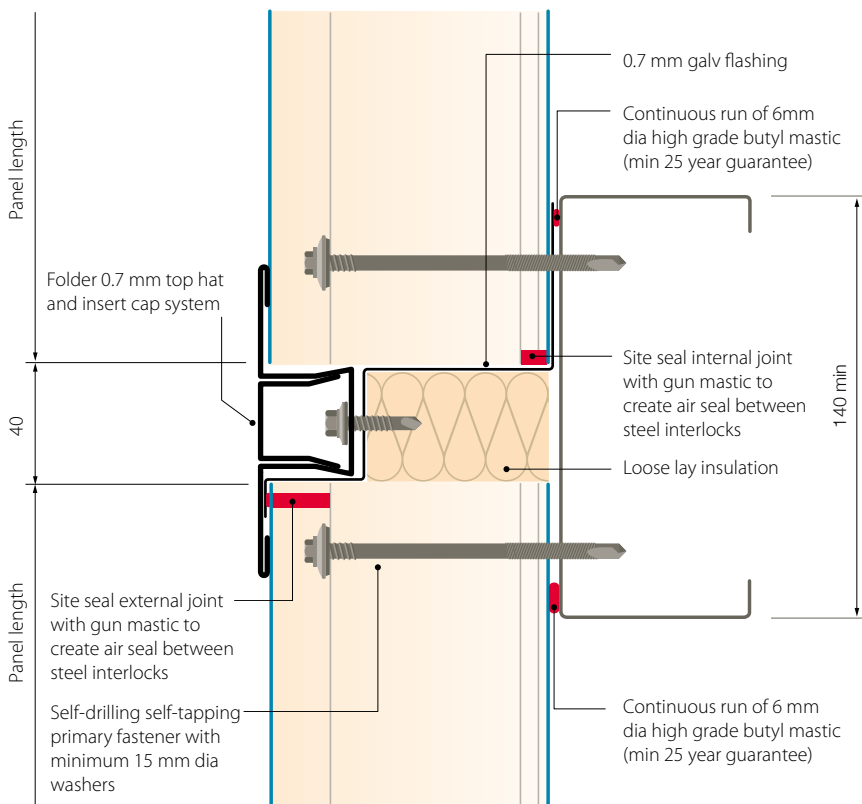

Stack joint

Ensure that the galvanised steel support angle is level and parallel with the panels below to facilitate installation and ensure a continuous run of vertical panels.

Psi value (W/mK)	f factor
1.103	0.579

Stated calculation results are dependant on components being as shown. Computer modelled in accordance with EN ISO 10211.

Internal corner

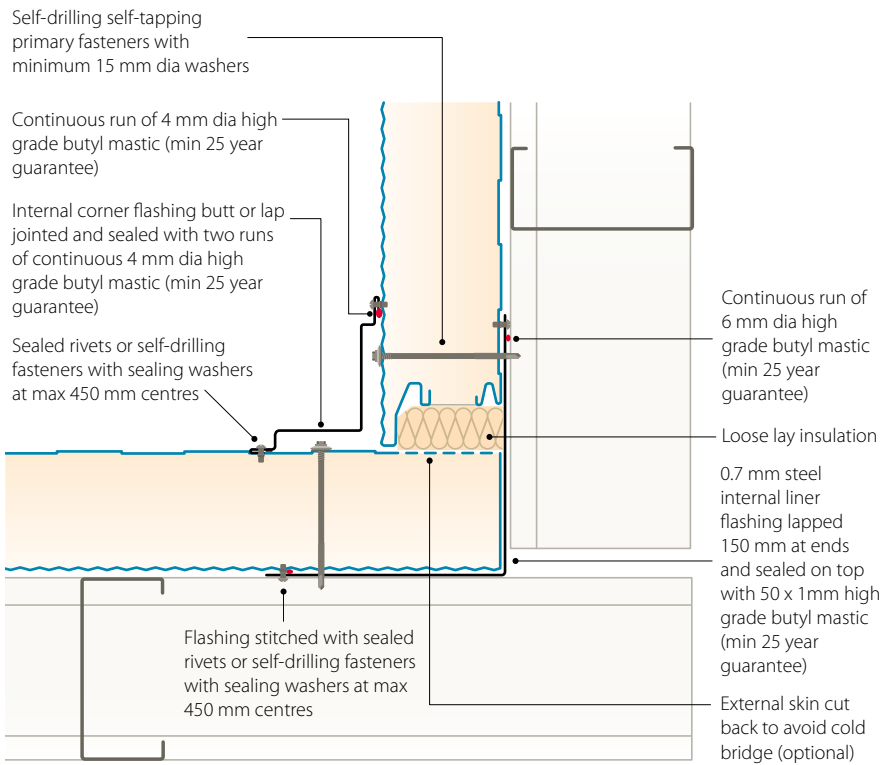

Internal corner

Thermal performance can be enhanced by the on-site removal of the panel outer skin within the corner junction, thereby reducing the risk of cold bridging. The outer skin can be easily removed by running a circular saw through the steel approximately 100 mm from the panel edge and peeling away the cut strip. Loose-laid insulation should be packed into any voids.

Psi value (W/mK)	f factor
With liner cut back	
0.011	0.977
Without liner cut back	
0.17	0.93

Stated calculation results are dependant on components being as shown. Computer modelled in accordance with EN ISO 10211.

Fabricated internal corner

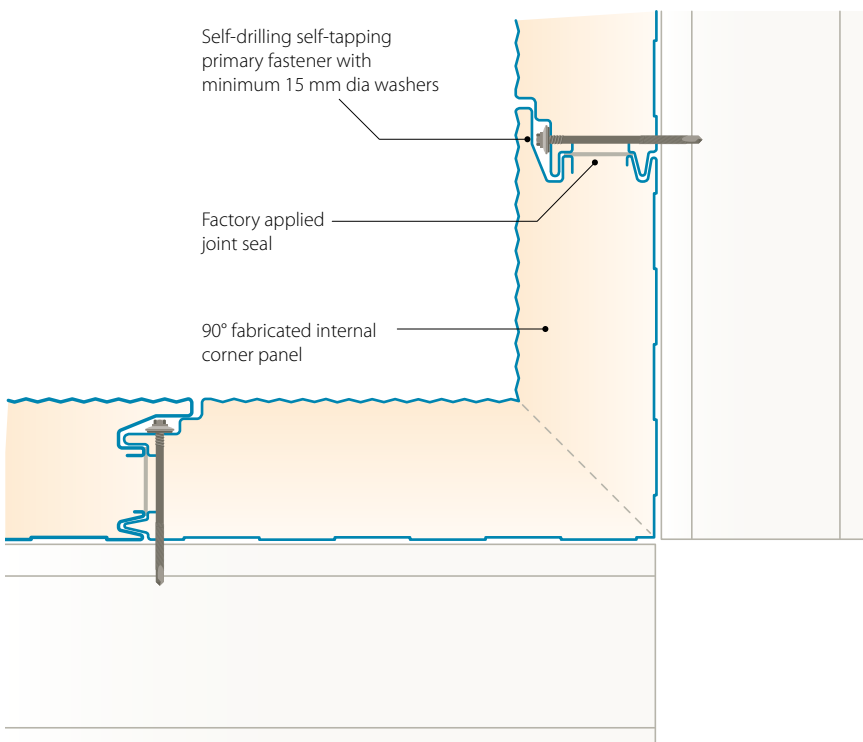

Fabricated internal corner

Factory fabrication provides an aesthetically pleasing solution to the corner detail and also provides a consistent thermal and air-tightness performance. The panel can be fabricated to a maximum length of 4 m.

Vertical construction details continued

External corner

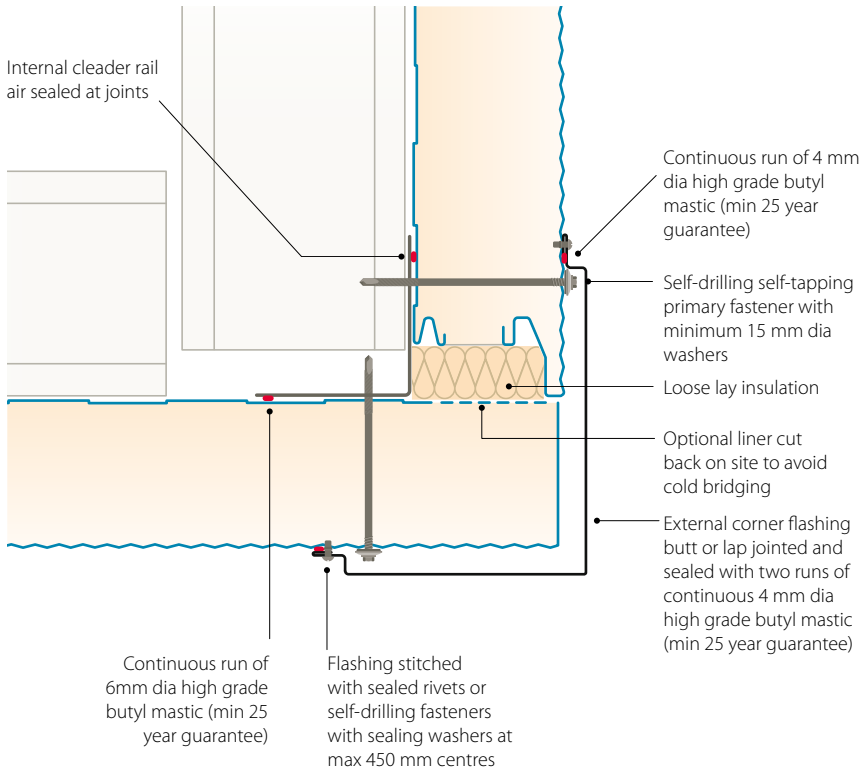

External corner

Thermal performance can be enhanced by the on-site removal of the panel liner within the corner junction, thereby reducing the risk of cold bridging. The liner can be easily removed by running a circular saw through the steel approximately 100 mm from the panel edge and peeling away the cut strip. Loose-laid insulation is to be packed into any voids.

Psi value (W/mK)	f factor
With liner cut back	
0.011	0.977
Without liner cut back	
0.17	0.93

Stated calculation results are dependant on components being as shown. Computer modelled in accordance with EN ISO 10211.

Fabricated external corner

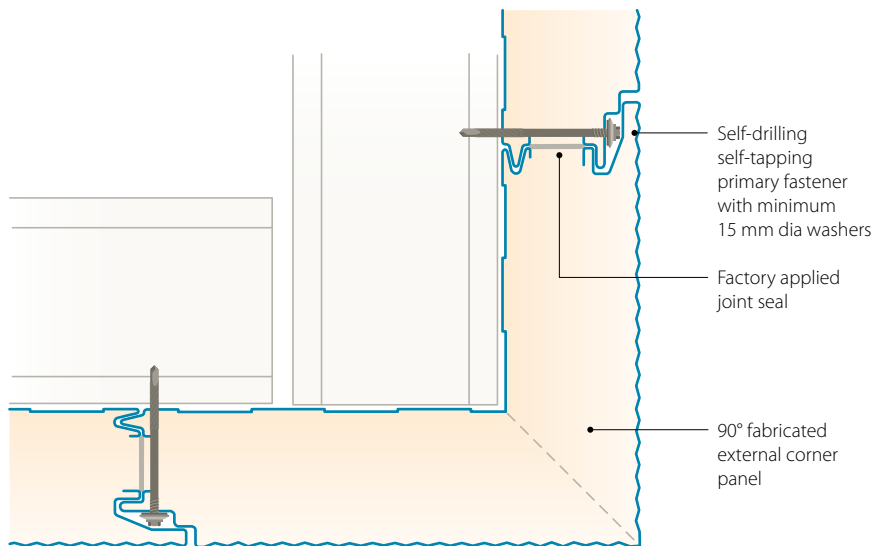

Fabricated external corner

Factory fabrication provides an aesthetically pleasing solution to the corner detail and also provides a consistent thermal and air-tightness performance. The panel can be fabricated to a maximum length of 4 m.

Drip detail base

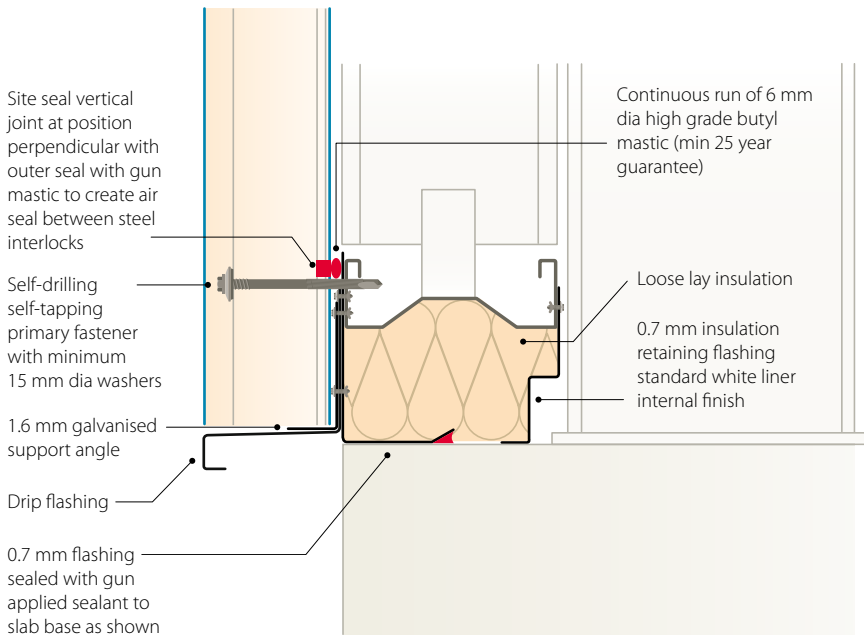

Drip detail base

A 1.6 mm galvanised steel support angle should be fixed to the support steelwork. It is important to ensure that this support angle is level before commencing installation.

Psi value (W/mK)	f factor
0.275	0.69

Stated calculation results are dependant on components being as shown. Computer modelled in accordance with EN ISO 10211.

Drip detail dado wall

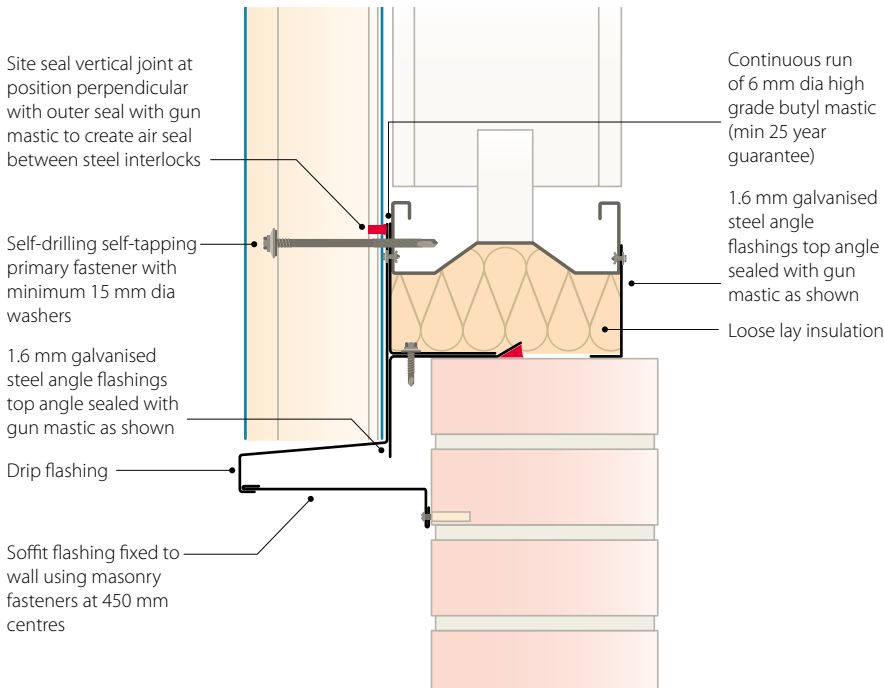

Drip detail dado wall

The back-to-back steel angles should be fixed together prior to positioning against bottom rail. This detail reduces cold bridging at this junction. Care must be taken not to over extend from wall capping both horizontally or vertically.

Psi value (W/mK)	f factor
0.484	0.702

Stated calculation results are dependant on components being as shown. Computer modelled in accordance with EN ISO 10211.

Vertical construction details continued

Window head and sill

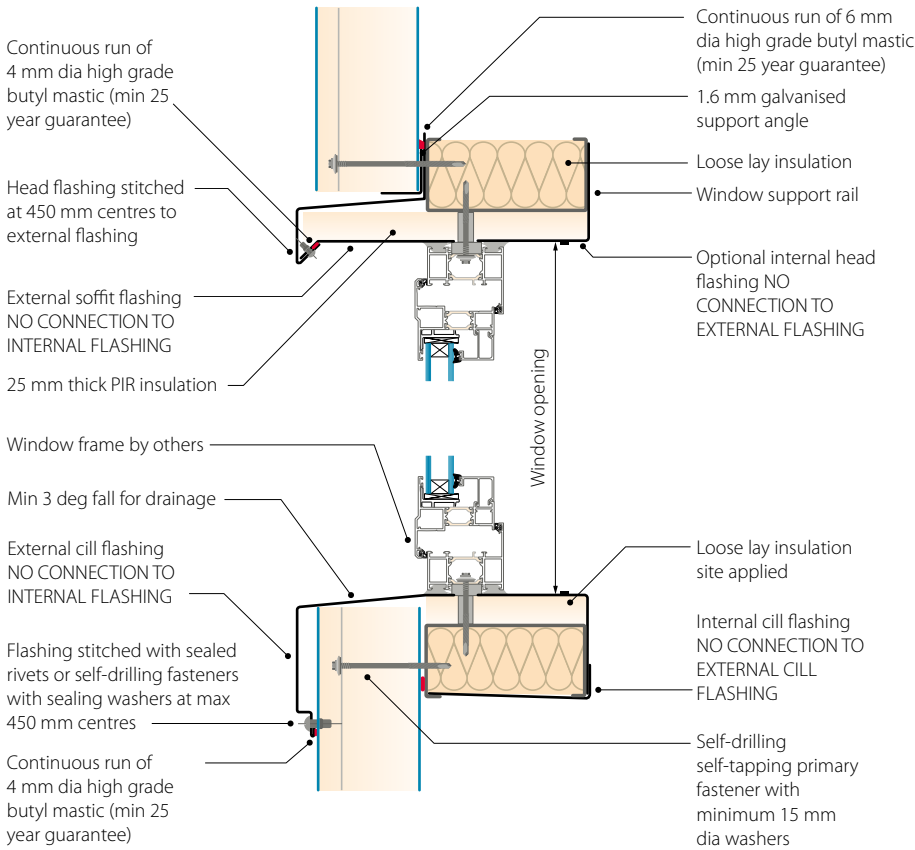

Window head and sill

The window flashing detail has been designed so that it can accommodate any proprietary window.

Psi value (W/mK)	f factor
With liner cut back	
0.614	0.725
Without liner cut back	
0.163	0.878

Stated calculation results are dependant on components being as shown. Computer modelled in accordance with EN ISO 10211.

Window jamb

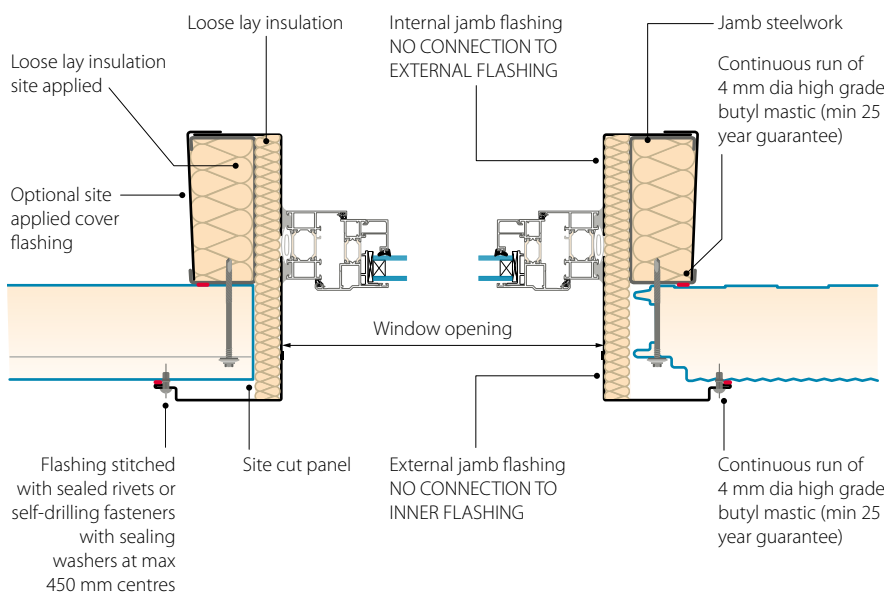

Window jamb

Trimming steelwork around the opening is required to support the window independently of the panels.

Vertical to horizontal break

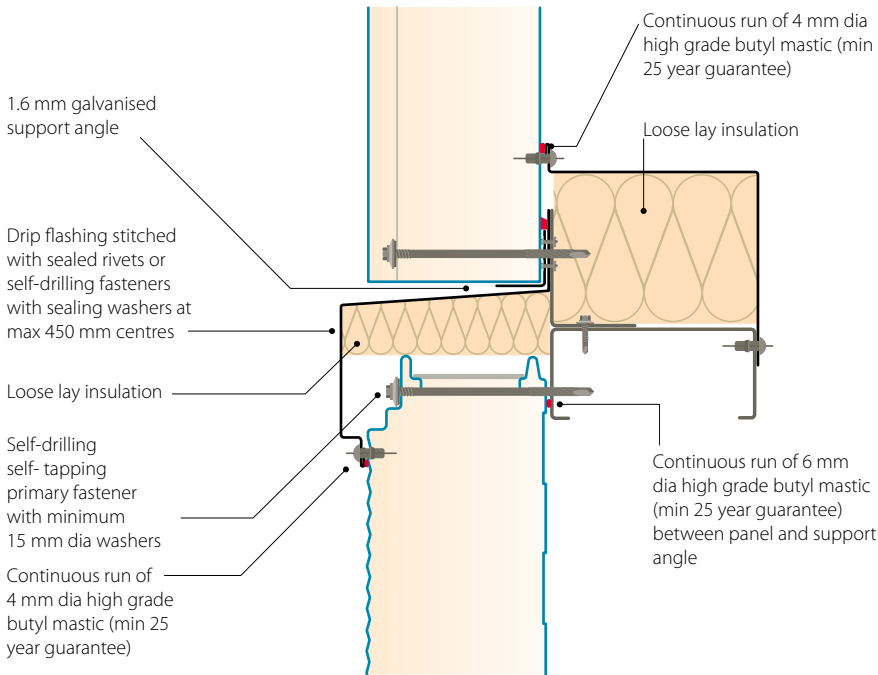

Vertical to horizontal break

Horizontal and vertical panels can be installed adjacent to each other to create interesting architectural features, while the drip flashing detail still maintains thermal performance and an efficient weather seal.

Psi value (W/mK)	f factor
0.103	0.579

Stated calculation results are dependant on components being as shown. Computer modelled in accordance with EN ISO 10211.

Brick wall abutment

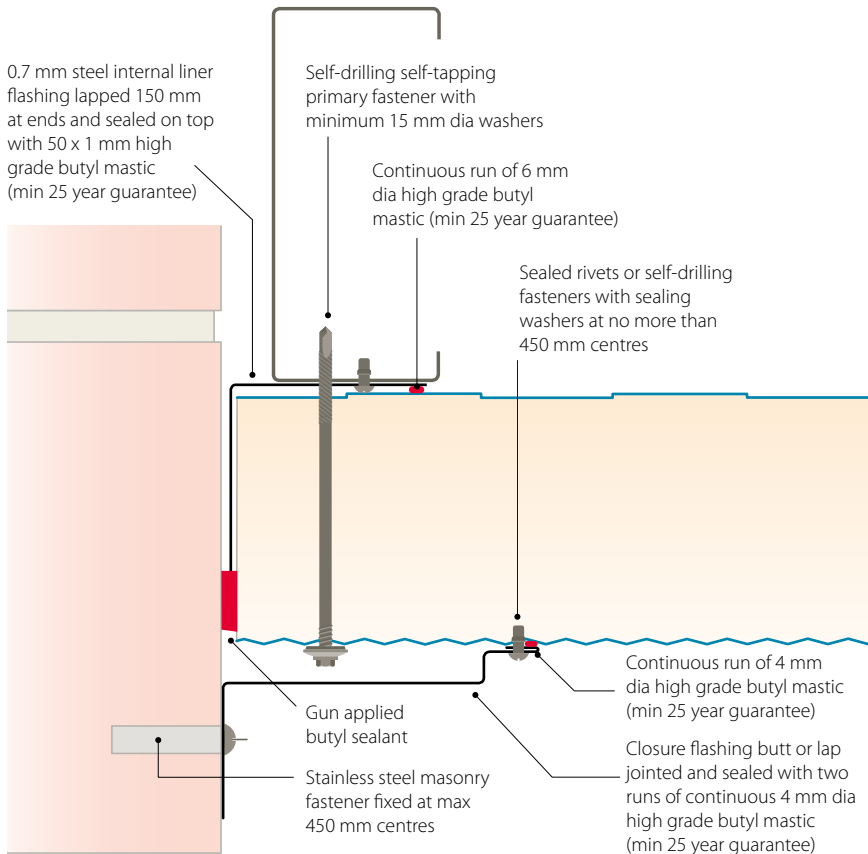

Brick wall abutment

Masonry fasteners should be stainless steel to maintain the durability of the system.

Psi value (W/mK)	f factor
0.26	0.84

Stated calculation results are dependant on components being as shown. Computer modelled in accordance with EN ISO 10211.

Integrated window

Specifying the Trimapanel® integrated window can enhance the systems architectural appearance. These windows provide a flush appearance that retains the uninterrupted appearance of the elevation.

Head detail

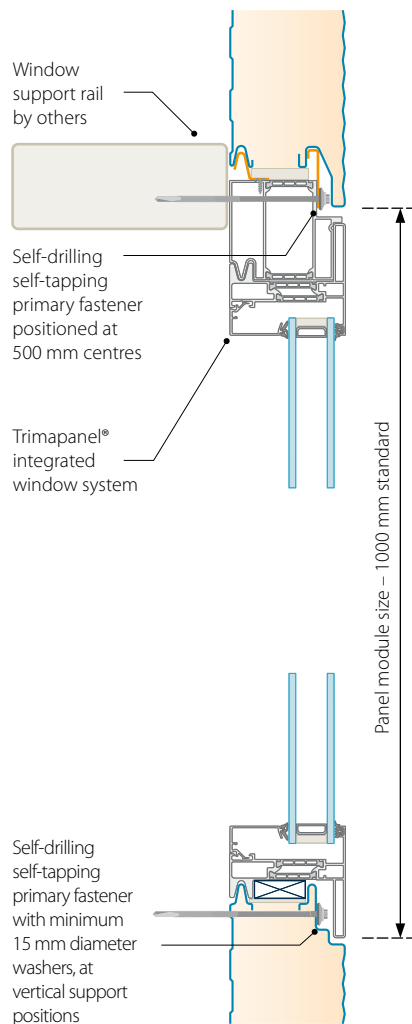

The aluminium frames can be powder coated to meet the panel finish or provide the designer with a stylish contrasting colour.

The Trimapanel® integrated window systems has a unique frame design which provides the ability to incorporate the window frame installation within the panel build and the option to glaze the window opening at a later date. This provides flexibility and fast program times and avoids costly delays waiting for the glazing element, which traditionally have longer lead times to the panel system.

The Trimapanel® integrated window system is available in three glazing options, which provide high-end functionality to more economic lighting solutions. The window frame can be delivered and installed alongside the Trimapanel® allowing the elevation to be completed without delay. The window can be fitted from the inside at a later date, providing flexibility and time savings to the build program. Framing clips and seals secure the window in place. These sections can be removed to allow replacement of the glazing element.

Vertical joint detail

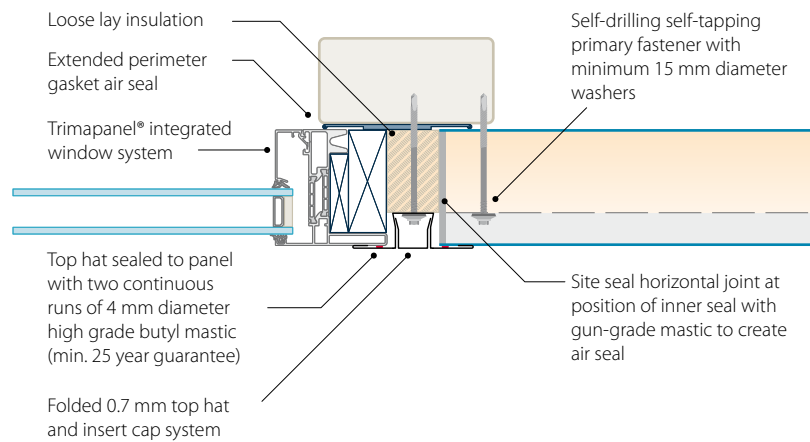

The window frame can be delivered and installed alongside the Trimapanel® allowing the elevation to be completed without delays.



The window can be fitted from the inside at a later date, providing flexibility and time savings to the build program.



Framing clips and seals secure the window in place. These sections can be removed to allow replacement of the glazing element.



Option 1- Schüco range

Tata Steel has chosen to partner with Schüco due to their reputation for quality, design excellence and system performance within the window industry. In addition to technical flexibility and numerous special features, the systems offer a variety of design options with excellent thermal insulation. Please contact our Technical department for the full range of options available. T: + 44 (0) 1244 892199.

Key Benefits

- Innovative technology.
- Wide range of units and opening types.
- Optional burglar, fire and bullet resistance.
- Schüco AvanTec - concealed fitting for vent weights up to 130 kg.
- Schüco TipTronic - mechatronic, concealed fitting for integration in the building management system.
- Frame design provides replacement of glazing element without disruption to envelope cladding.



Option 2 - Standard Glass

A fixed clear glass option offers a more economical glass finish to that of the more versatile Option 1. It is available in various specifications for strength, thermal insulation noise and solar shading. This option provides a high quality finish which maximises the available glazing area and light transmission.

Key Benefits

- Large glazing area providing maximum light transmission and vision area.
- Shorter lead times on glazing elements.
- Frame design provides replacement of glazing element without disruption to envelope cladding.



Option 3 - Polycarbonate

The specified Polycarbonate systems used within the Trimapanel® integrated window are all from Platinum® Plus Approved Suppliers and all utilise unique interlocking glazing panels manufactured from multiwall polycarbonate sheet which simply click and fix into place for a completely seamless façade. The polycarbonate is available in both clear and opal finishes in a range of colour tints.

Key Benefits

- Large glazing area providing maximum light transmission.
- Shorter lead times on glazing elements.
- Economical solution for lighting solutions.
- Vertically run polycarbonate glazing avoiding issues with condensation within panel.
- Frame design provides replacement of glazing element without disruption to envelope cladding.

Site guidance

This guide assumes that all current safety regulations are in place before the installers commence work.

Packaging

The number of panels in each pack will vary with the length of the panel to ensure stability (see table below). Typically, panels are packed in stacks up to 1,100 mm high. The panels are protected by a baseboard and are plastic wrapped in the factory. If required, panels can be grouped and referenced for particular areas of the building (eg, grid line, elevation reference). As standard, each pack is labelled with the order reference number, the number of panels and the panel length.

Maximum number of panels within a pack for varying panel lengths

Trimapanel® System	Lengths (m)			
	<5	5-7	7-9	9-12
70	13	10	8	7
90	11	8	6	5
120	8	7	6	5

Receipt of materials on-site

All materials arriving on-site must be checked promptly before off loading. Checks should be made against the relevant delivery notes to ensure that the correct quantities and specifications have been delivered and to determine any possible transportation damage. Any discrepancies or damage observed should be recorded immediately on the proof of delivery paperwork, and a written report should be submitted within 21 days. Please note that off loading is the customer's responsibility.

Off loading

Wherever possible, the Trimapanel® System should be off loaded directly from the vehicle to the area where they will be used to reduce the risk of on-site damage. Off loading is to be undertaken as per Tata Steel recommendations. If panels are to be stored before installation, they should be placed on level ground (in accordance with storage instructions opposite).

There are two recommended methods for off loading:

- **Forklift or telehandler:** These can be used when off-loading panels less than 6 m long. Care must be taken not to tip or damage the bottom panel when driving on uneven ground. Only **one** pack at a time should be unloaded. Open forks fully before lifting.
- **Crane:** Where slings or grabs are used, precautions should be taken to prevent edge damage and to avoid pressure across the panels, which may cause distortion (chains should not be used). When lifting panels over 6 m long, a spreader bar with sufficient hoisting belts to spread the load should be used. If required, temporary edge protection can be installed to prevent local damage. Only **one** pack at a time should be off-loaded.

Packaging: Stacked panels

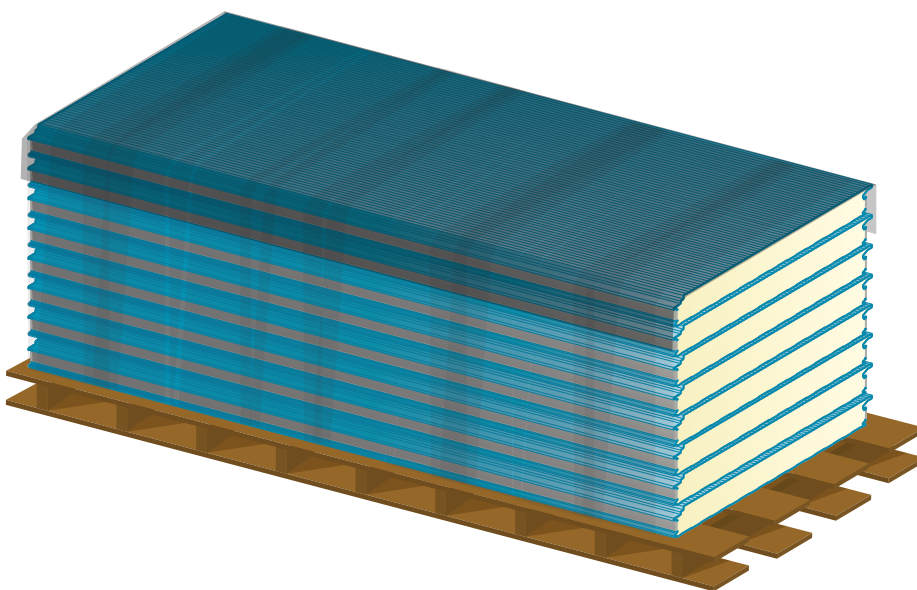

Storage

In addition to the guidelines above, the bundles should be stored on level ground (eg., a floor slab). The packs should never be stacked more than two high. There should be adequate separation between stacks to provide access and to avoid end damage.



1. Do not stand uncovered stacks in the open. Store under cover and away from open doorways.



2. If stacks cannot be stored under cover, erect a simple scaffold around them and cover it with a waterproof sheet, tarpaulin or polythene. Leave space between cover and sheets to allow air to circulate.



3. Store stacks off the ground and on a slope, so that should rain penetrate the cover, the water will drain away.



4. Inspect the storage site regularly to ensure that moisture, despite the above precautions, has not penetrated the stack.



5. Do not store sheets where people will walk across them.

Protective film

The Trimapanel® System is supplied with protective film on the external face. The film has a limited shelf life and must not be exposed to sunlight for long periods as it is susceptible to ultraviolet degradation. This makes the film difficult to remove and may result in adhesive residue that causes dust and dirt to adhere to the decorative finish. To ensure easy, clean removal, remove the film within one month of panel delivery to site.

Pre-erection checks

A secondary support structure is required to support the cladding system at the necessary positions and transfer all loads imposed on and by the cladding system back to the primary structure.

Before any work starts, a full survey or inspection should be carried out to ensure that the support steelwork and any other associated materials, is correctly positioned and within tolerance so that the Trimapanel® System can be fixed correctly. Any obvious problems should be immediately reported to the main contractor to enable remedial work to be undertaken before installation of the cladding.

Tata Steel recommend the allowable variation in the outer flange level of the cladding rail with respect to a vertical datum line is $L/600$ (where L is the rail spacing).

Further guidance on steelwork tolerance can be found in a Steel Construction Institute publication P346: *Best Practice for the specification in installation of metal cladding and secondary steelwork*.

Handling

Wherever possible, manual handling should be avoided and mechanical handling equipment should be used. Mechanical handling provides health and safety benefits, shorter installation times, smaller installation teams and less risk of panel damage. When using suction lifting equipment ensure that the panel is turned vertically soon after lifting from the pack to avoid any risk of marking on the panel face and also when positioned ensure that the panel is secured to the structure before releasing from the lifting equipment.

Recommended suppliers

Gould Plant Hire
T: +44 (0) 1527 570111

4 Cladding Services
T: +44 (0) 8707 417600

Cutting

For making small cut-outs, openings and cuts that are not straight, use a jigsaw or a reciprocating saw. For longer straight cuts, we recommend using a circular saw that produces a cold cut with a fine-tooth metal cutting blade (ie., not a grinding blade, as this hot cut will damage the coating). All cutting should be undertaken at ground level.



Handling panels



Site guidance continued

Installation – panel

The steps given below are instructions for a typical construction and should be used only as a guide. Specific technical details, method statements and site-specific risk assessments should be produced and applied for each building. An extended list of robust details is available from Tata Steel, and advice can be given via our technical department on any bespoke details that may be required.

The following steps apply to a wall made up of multiple panels with butt joints.

Figure 1 – Base detail preparation

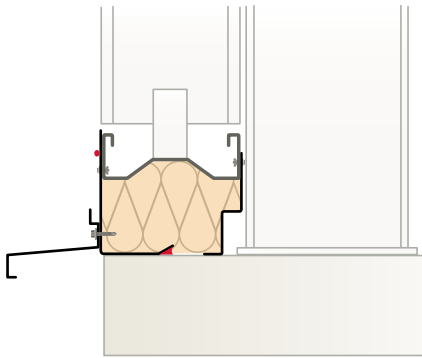
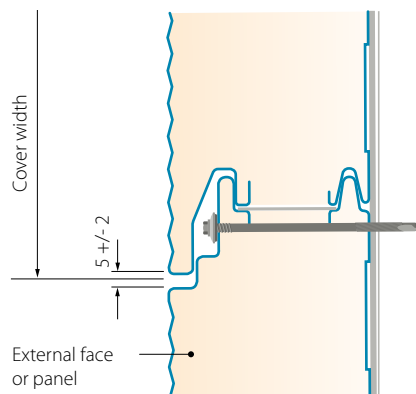

Figure 2 – Panel joints



Horizontal wall installation

1. Carry out preparation work on sill trims and panel bearers (maximum 1,000 mm centres) for the first panel, see Figure 1. Ensure that these are lined, levelled and sealed as specified. Run a continuous length of perimeter seal (90 mm wide) down the vertical supports central to the panel module. Ensure that this seal overlaps the drip flashing.
2. Sit the first panel on the panel bearers so that the liner interlocks. Check that the ends of the panel have the correct land on the vertical supports (minimum 50 mm land), are overlapping the perimeter seal, and allow enough room for the next tier of panels at the specified joint gap. Once the panel is correctly positioned, fix the top edge with the specified number of fasteners per vertical support. Make sure that the fastener is not over tightened, and clean away drilling swarf from the joint to avoid rust marks. Apply gun-applied solvent-release bedding sealant at the panel ends to seal the gaps at the external and internal joint areas before lapping the next panel.
3. Continue to the top of the wall. If the top panel requires cutting, through fix back to an eaves beam support at a maximum of 1,000 mm centres, at no less than 30 mm from cut edge. A cover flashing or gutter line is normally used to conceal these fixings.
4. Continue with next tier of panels following instructions from Figure 2 onward.
5. Once the elevation is complete, fix the vertical joint flashing. Figure 3 below shows the installation of the top hat arrangement.

Figure 3 – Trimapanel® System top-hat installation

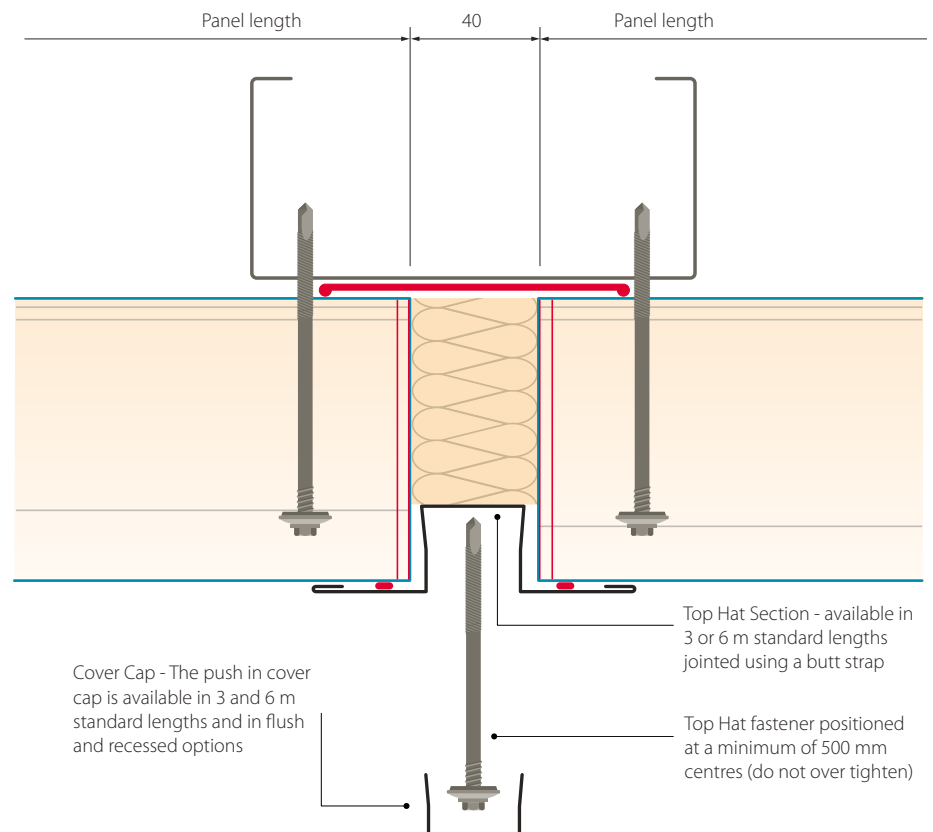

Vertical wall installation

1. Checks should be carried out to make sure that the bottom rail is adequately supported and level along its full length before commencing with the installation.
2. Carry out preparation work on sill trims and panel bearers for the first panel. Ensure that these are lined, levelled and sealed as specified, see Figure 4.
3. Position the first panel with its female edge towards the corner of the building. Before inserting the fasteners, ensure that
 - a. the setting-out dimensions are observed. Failure to comply with these dimensions may lead to problems later in the section.
 - b. the panel is plumb using a plumb line
 - c. the position of the panel relative to the bottom and top or intermediate rails is correct. Check this with the erection drawings.
4. At each horizontal rail position, fix the first panel at the male edge (at concealed position), and through fix at the female edge with the specified number of fasteners. Make sure that the fastener is not over tightened, and clean away drilling swarf to avoid rust marks.
5. Hoist subsequent panels into position and engage the lips with the adjacent panels. Maintain a uniform side joint to meet the panel cover width and setting out dimensions, see Figure 2 for joint gap dimensions. Continue along elevation until the wall is complete. If the end panel requires cutting, fix back to the vertical corner support at a maximum of 1,000 mm centres, no less than 30mm from the panel cut edge. A cover flashing is normally used to conceal these fixings.

Figure 4 – Base detail

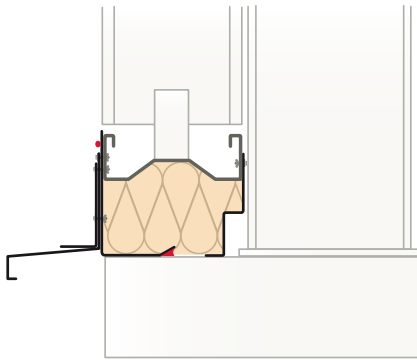

6. If another layer of panels is required above, prepare the stack joint detail, see Figure 5, and start the procedure again

Figure 5 – Stack joint detail

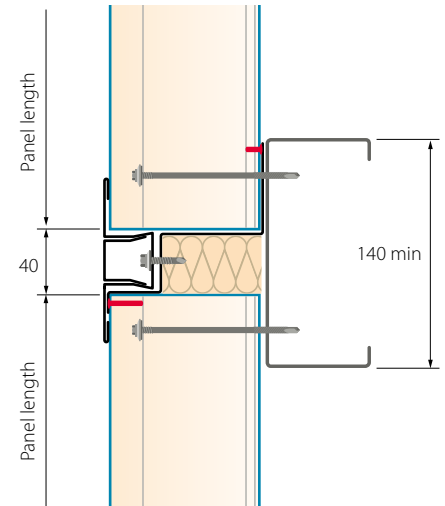

Removal of protective film

Trimapanel® System can be supplied with protective film on the external face. This is designed to provide additional protection during manual handling and site fixing. The film has a limited shelf life and must not be exposed to sunlight for long periods because it is susceptible to ultraviolet degradation. This makes the film difficult to remove and may result in adhesive residue that causes dust and dirt to adhere to the decorative finish. To ensure easy, clean removal, remove the film within one month of panel delivery to site.

Fasteners, sealants and fillers

The primary fasteners for securing the Trimapanel® System to structural steel have been purpose designed to facilitate speed of fixing, give structural security with reduced risk of over compression and have minimal thermal bridging.

Fastener summary

Application	Panel thickness (mm)	SFS intec	Ejot UK
Primary fixing to cold-rolled rails:	70	SXC5-S16-5.5x95 A4	JT3-D6H 5.5/6.3 x 87 S16
	90	SXC5-S16-5.5x115 A4	JT3-D6H 5.5/6.3 x 107 S16
	120	SXC5-S16-5.5x135 A4	JT3-D6H 5.5/6.3 x 127 S16
Top-hat fastener at vertical joint and stack joint positions to cold-rolled rails:	70	SXC5-S16-5.5x95 A4	JT3-D6H 5.5/6.3 x 87 S16
	90	SXC5-S16-5.5x115 A4	JT3-D6H 5.5/6.3 x 107 S16
	120	SXC5-S16-5.5x135 A4	JT3-D6H 5.5/6.3 x 127 S16
Primary fixing to hot-rolled rails:	70	SXC14-S16-5.5x100 A4	JT3-D12H 5.5/6.3 x 95 S16
	90	SXC14-S16-5.5x120 A4	JT3-D12H 5.5/6.3 x 115 S16
	120	SXC14-S16-5.5x140 A4	JT3-D12H 5.5/6.3 x 135 S16
Top-hat fastener at vertical joint and stack joint positions to hot-rolled rails:	70	SXC14-S16-5.5x100 A4	JT3-D12H 5.5/6.3 x 95 S16
	90	SXC14-S16-5.5x120 A4	JT3-D12H 5.5/6.3 x 115 S16
	120	SXC14-S16-5.5x140 A4	JT3-D12H 5.5/6.3 x 135 S16
Base support clip fastener into cold-rolled rail:	N/A	SX3/9-S16-6.0x29 A4	JT3-3-5.5x35 S16
Base support clip fastener into hot-rolled rail:	N/A	SX14/12-S16-5.5x40 A4	JT3-12-5.5x40 S16
External stitching screw for metal flashing to panel:		SL2-S-S14-5.5x27 A4 + COLOUR	CF15 JT3-2-6.3x25 + COLOUR
External rivet for metal flashing to panel:		ATOM-D-48143 + COLOUR	ALV-4.8x15 + COLOUR

When fixing to timber, fastener pullout values may limit the ability of the wall to resist wind uplift loads. If in doubt, consult Tata Steel.

All fasteners can be sourced from SFS intec T: +44 (0) 113 208 5500 or EJOT UK Limited T: +44 (0) 1977 687040.

Sealants and gaskets

For panel ends at eaves, bases and corners, seal against the internal flashing with a 6 mm diameter high grade butyl mastic. Internal flashing joints should use a 50 x 1 mm high grade butyl mastic. External flashing joints should use a 4 mm diameter high grade butyl mastic. All mastic should carry a 25 year guarantee (ie, Pink, Blue or White Strip).

At vertical butt joints of horizontally laid panels, a 90 mm perimeter gasket should be used between the panel joint and laid continuously over the supporting steelwork. At corners and vertical junctions, the joint gap between the panels should be filled using a gun-applied solvent-release bedding sealant.

All sealants can be sourced from the following suppliers:

Premier Sealants (White strip),
T: +44 (0) 1724 864100
EJOT UK Limited (Blue Strip).
T: +44 (0) 1977 687040
SFS intec (Pink Strip).
T: +44 (0) 0113 208 5500

The perimeter gasket is supplied by Tata Steel.



Client: Hambleside Danelaw

Architect: G4 Design

Installing contractor: Howard Evans Roofing

Cladding system: Trimapanel® System

Colorcoat® product: Colorcoat Prisma® in Silver Metallic

Application: Wall cladding for new manufacturing unit

www.tatasteelconstruction.com

Trademarks of Tata Steel UK Limited

Colorcoat, Colorcoat Connection, Colorcoat HPS200 Ultra, Confidex, Platinum Plus, Colorcoat Prisma, Galvalloy, Trimapanel and Trisomet are registered trademarks of Tata Steel UK Limited.

Care has been taken to ensure that the contents of this publication are accurate, but Tata Steel Europe Limited and its subsidiaries, (including Tata Steel UK Limited), do not accept responsibility or liability for errors or information that is found to be misleading. Suggestions for, or descriptions of, the end use or application of products or methods of working are for information only and Tata Steel Europe Limited and its subsidiaries accept no liability in respect thereof.

Before using products or services supplied or manufactured by Tata Steel Europe Limited and its subsidiaries, customers should satisfy themselves as to their suitability.

Printed with biodegradable vegetable inks on material sourced from responsibly managed forests, certified in accordance with the FSC. Contains 10% recovered fibre, diverting waste from landfill.

Copyright 2015 Tata Steel

Tata Steel

Shotton

Deeside

Flintshire

CH5 2NH

T: +44 (0) 1244 892199

F: +44 (0) 1244 892121

www.tatasteelconstruction.com

Tata Steel UK Limited, is registered in England under number 2280000, with registered Office at 30 Millbank London SW1P 4WY.

Copyright 2015 Tata Steel

Language English TSBS02:PDF:ENG:1115